



NATURAL GAS

Line extension and
service standards

- 2024 -



Colorado Springs Utilities
It's how we're all connected

Pursuant to Colorado Springs City Code Section 12.1.110, on October 26th, 2023, Colorado Springs Utilities provided public notice of its intent to amend the Gas Line Extension and Service Standards. No substantial comments to these Standards and no request for a hearing were received. Therefore, Colorado Springs Utilities does hereby amend the Gas Line Extension and Service Standards as Colorado Springs Utilities policy to become effective on January 1st, 2024.



Somer Mese, Chief Operations Officer

11/15/2023
Date Approved



Lisa Barbato, Chief System Planning & Projects Officer

11/15/23
Date Approved

Legal Notice and Disclaimer

Under no circumstances will Colorado Springs Utilities, its employees or agents be liable for any direct, indirect, punitive or consequential damages that may result in any way from use, misuse, reference in or reliance on any of the information provided in or through this or any other publication or Web site including those sites which are linked herein, or that result from mistakes, errors omissions, interruptions, defects or any failure of performance.

COLORADO SPRINGS UTILITIES EXPRESSLY DISCLAIMS ALL WARRANTIES, INCLUDING ANY EXPRESS OR IMPLIED WARRANTIES OF MERCHANTABILITY OR FITNESS FOR A PARTICULAR PURPOSE WITH RESPECT TO THE INFORMATION HEREIN.

While every effort is made to present accurate and reliable information, Colorado Springs Utilities does not endorse, approve or certify the information provided by others, nor guarantee its accuracy, completeness or timeliness. Use of the information is voluntary and reliance on it should only be undertaken after the user has independently verified its accuracy, completeness and timeliness.

COLORADO SPRINGS UTILITIES GAS LINE EXTENSION & SERVICE STANDARDS

Table of Contents

Chapter	Title	Page Number
Disclaimer		
Table of Content		i
Revision Table		ii
1	General Information.....	1-1
2	Gas Main/Service Stub Extension	2-1
3	Utility Service Installer License Rules & Procedures	3-1
4	Service Line Design and Construction	4-1
Appendix A	Service Area Map	A-1
Appendix B	Utilities Addressing Plan (UAP)/Utilities Design CAD File (UDCF)	B-1
Appendix C	Tables	C-1
Appendix D	Figures	D-1
Appendix E	Glossary	E-1
Appendix F	Colorado Springs Utilities Plastic Joining Procedure (Socket only)	F-1

Phone Numbers & Contact Information

Natural Gas Line Extension & Service Standards

2024 Revision Table

(To the 2023 Natural Gas Line Extension and Service Standards)

CHAPTER	TITLE	REVISION DESCRIPTION AND RATIONALE
All		Changed reference to 150P system to high pressure distribution system. Requested by Josh Dudeck/Gas Advanced Design. Changed department names as appropriate.
1.03	Excavation and Boring Requirements near Utility Lines	Referenced Table 8 for information on potholing requirements for private fiber installation using trenchless technologies near gas mains.
1.03	Excavation and Boring Requirements near Utility Lines	Added contact information for Damage Prevention.
1.03	Excavation and Boring Requirements near Utility Lines	Added statement that flowfill in joint trench areas behind curb is not allowed. Requested by Mike F/QC Inspections
1.03	Excavation and Boring Requirements near Utility Lines	Added statement that Contractors working within the City shall also comply with the City’s pothole backfilling requirements based on receipt of revised City pothole requirements.
2	Application for Gas and Electric Line Extension	Removed note in form about private communications facilities being installed in joint trench with electric as this is no longer allowed. Joint Trench is limited to Colorado Springs Utilities’ fiber & utilities. Requested by Bill Galloway/Engr Standards
3.02 a)	Utility Service Installer License Process	Added the requirement that LUSIs must be enrolled in Utilities’ drug and alcohol testing compliance monitoring program through DISA Compliance Monitoring (DCM Reporting) and have been issued a satisfactory rating. This replaces the Affidavit of Drug and Alcohol compliance, and references throughout Chapter 3 have been removed as well as the Affidavit itself. In addition, clarified various statements in Chapter 3. Requested by Mary Kurth/ Regulatory & Compliance and Christie McCall/Attorney’s Office.
3.02 a)	Utility Service Installer License Process	Denial of or failure on a third TPE attempt shall deem the applicant no longer eligible to be qualified for a period of two years (added 2 years). This makes the timing similar to re-licensure when the license is revoked. Christie McCall/Attorney’s Office.
3.02 b)	Certificate of Insurance	Pikes Peak Regional Building Department (PPRBD) requires that the Certificate of Insurance must also include the 10-day Cancellation/Reduction Clause. Added this in the text.
3.02 c)	Drug and Alcohol Program	Requires LUSIs or employer to 1) register with DCM Reporting; 2) submit required documentation and 3) maintain satisfactory rating at all times. Mary Kurth/ Regulatory & Compliance

Natural Gas Line Extension & Service Standards

2024 Revision Table

(To the 2023 Natural Gas Line Extension and Service Standards)

3.02 c)	Drug and Alcohol Program	Noncompliance, or failure to achieve and maintain a satisfactory rating through DCM Reporting will result in suspension or revocation of all LUSIs subject to such program. Mary Kurth/Regulatory & Compliance and Christie McCall/Attorney's Office
3.02 d)	Utility Service Installer License Renewal, Suspension and Revocation Process	When a Utility Service Installer commits a Violation, the Utility Construction and Maintenance Department Manager may immediately suspend the LUSI or, alternatively, recommend that the LUSI be suspended upon a stated future date, but in either case the suspension shall be for a minimum period of 30 days and until all requirements for re-instatement are met. Mary Kurth/Regulatory & Compliance and Christie McCall/Attorney's Office
3.02 d)	Utility Service Installer License Renewal, Suspension and Revocation Process	Clarified automatic suspension occurs if have not had a fusion inspection within 12 months or if the license has expired and the LUSI has not completed all required re-testing. Christie McCall/Attorney's Office
3.02 d)	Utility Service Installer License Renewal, Suspension and Revocation Process	Revocation of Utility Service Installer license will occur pursuant to the Code of the City of Colorado Springs when the LUSI experiences, or fails to notify Utilities of, a positive, refusal, or non-negative drug or alcohol test (as defined by 49 CFR Parts 40 and 199). Mary Kurth/Regulatory & Compliance and Christie McCall/Attorney's Office
3.02 d)	Utility Service Installer License Renewal, Suspension and Revocation Process	Modified section regarding suspension, revocation and reinstatement process to include pre- and post-deprivation appeals. Christie McCall/Attorney's Office
4.05)d)4)	Additional Requirements	Require that Field Engineering is contacted if wanting a backup generator at a commercial property. The generator may need to be on its own meter. Requested by Zach Meyer/Field Services
Appendix B	Easements	Referred easement details to the Construction and Development Hub
Appendix C	Table 7: Materials	LUSIs can use vertical risers with the permission of QC Inspector Supervisor. Needed due to tight spaces. Requested by Mike F/QC Inspection
Appendix C	Table 7: Materials	Caution Tape added as an option
Appendix C	Table 8: Clearance Matrix	In certain joint trench situations 3' of clearance between fiber and gas main may be allowed when using listed best practices. Review of this standard requested by Charlie Cassidy.
Appendix C	Table 8: Clearance Matrix	Changed separation from electric primary to metallic gas main to 3' from 5'. Requested by Mike F/QC Inspections. Josh Dudeck and Kathryn Rozwod have okayed this change. 1) The threat of electric ground fault is likely equal for both plastic and steel gas pipe and vertical separations likely don't make a huge difference in varying soil conditions. 2) It seems unlikely (random chance)

Natural Gas Line Extension & Service Standards

2024 Revision Table

(To the 2023 Natural Gas Line Extension and Service Standards)

		that would occur right at the location of the infrastructure crossing. 3' separation should be kept for maintenance purposes/anode installation (need 3' horizontal)
Appendix D	Figure 1	Joint Trench is limited to Colorado Springs Utilities' fiber & utilities. Requested by Bill Galloway/Engr Standards
Appendix D	Figure 8B and 8C	Changed gas service riser to 16"-18" out from the final exterior finished surface (matches table in Figure 6)
Appendix D	Figure 16	Joint Trench is limited to Colorado Springs Utilities' fiber & utilities. Requested by Bill Galloway/Engr Standards
Appendix F		References to code requirements added

TABLE OF CONTENTS

CHAPTER 1 General Information

Paragraph Number	Title	Page Number
1.01	Purpose	1-2
1.02	General Policy Information	1-2
1.03	Excavation & Boring Requirements near Utility Lines	1-4
1.04	Locating Responsibility.....	1-7
-	Request for Removal of Utilities- Demolition or Construction	1-8
-	Natural Gas Customer Buried Piping Safety Notice.....	1-10

CHAPTER 1

General Information

1.01 Purpose

These standards are issued by Colorado Springs Utilities for Colorado Springs Utilities infrastructure as requirements for obtaining gas service and gas main line extensions and to put forth the service available, conditions for service, and the standards for material and construction. The requirements of the chapter text, tables and drawings apply. The standards herein supersede all previous publications of those standards issued by Colorado Springs Utilities prior to this date and are subject to change without notice.

These standards are provided to assist customers, architects, engineers, contractors, developers, and Licensed Utility Service Installers (LUSI) in planning and applying for gas service from Colorado Springs Utilities. These regulations and policies serve to provide safety guidelines for new service lines and main extensions and procedural direction to expedite service connection by establishing uniform standards for gas service. No one rule or instruction covers all conditions. For conditions not specifically covered within these standards, the customer shall defer to the Colorado Springs Utilities Field Engineering's, Gas Construction Section Leaders' or Quality Control Inspection Supervisor's decision on the appropriate course of action.

Any contractor requesting natural gas service from Colorado Springs Utilities is responsible for providing copies of the most recently published specifications to potentially affected subcontractors and bidders responding to solicitations involving work related to new gas service lines. Copies of this manual are available online <https://www.csu.org/Pages/ConstructionStandards.aspx> or from:

Colorado Springs Utilities
Gas Line Extension & Service Standards
1521 Hancock Expressway (Mail Code 1812)
Colorado Springs, CO 80903

1.02 General Policy Information

- a) The standards herein are supplementary to, and are not intended to conflict with, the rules and regulations on file with the City Clerk of the City of Colorado Springs or applicable city ordinances.
- b) The City of Colorado Springs City Code Chapter 12 requires compliance with the latest version of the US Department of Transportation Safety Code concerning natural gas (i.e., 49 CFR Part 192). Updates to Gas Line Extension & Service Standards are periodically required to ensure compliance with 49 CFR Part 192.
- c) As a condition of service, the customer will give the duly authorized agents and employees of Colorado Springs Utilities, when properly identified, full and free access to the premises of the customer at all reasonable hours. This access will be for the purpose of installing, reading, inspecting, adjusting, repairing, maintaining, replacing or removing any of Colorado Springs

Utilities facilities on the premises of the customer or for any other purpose incidental to the gas service supplied by Colorado Springs Utilities.

- d) Employees of Colorado Springs Utilities may not demand nor accept any compensation from a customer for services rendered in the line of duty. However, certain employees do collect money from customers for settlement of accounts due to Colorado Springs Utilities and of which the customer is already aware.
- e) The customer will not bypass, tamper with, engage in unauthorized metering, or otherwise interfere with the proper operation of Colorado Springs Utilities meter or other equipment or in any way interfere with the proper metering registration.

For violation of this regulation, service will be disconnected without notice to the customer and will not be reconnected until the customer has corrected such violation in accordance with prevailing gas requirements. The customer may be billed the costs incurred by Colorado Springs Utilities to resolve the situation as well as the outstanding charges.

- f) The customer will protect the property of Colorado Springs Utilities on their premises at all times and will not permit persons other than the employees and agents of Colorado Springs Utilities and other persons authorized by law to inspect, work on, open, or otherwise handle the meters or other facilities of Colorado Springs Utilities. In case of loss or damage to the property of Colorado Springs Utilities due to carelessness, neglect, or misuse by the customer, his family, agents, servants, or employees, the customer will, at the request of Colorado Springs Utilities, pay to Colorado Springs Utilities the cost of any necessary repairs or replacement of such facilities or the value of such facilities.
- g) Devices or attachments will not be connected to Colorado Springs Utilities facilities in such a manner as to permit the use of unmetered energy without the prior written consent of Colorado Springs Utilities.
- h) The rates for all types of gas service supplied by Colorado Springs Utilities are on file with the City Clerk's Office, the Pricing Division, and on the Colorado Springs Utilities website at <https://www.csu.org/Pages/RatesTariffs.aspx>. Upon request, a representative of Colorado Springs Utilities will explain rate schedules and assist in selection of the applicable rate best suited to the customer's requirements.
- i) Colorado Springs Utilities will use reasonable diligence to supply continuous gas service to the customer but does not guarantee the supply of gas service against irregularities or interruptions. Colorado Springs Utilities will not be considered in default of its service agreement with the customer and will not otherwise be liable for any damages incurred by any irregularity or interruption of gas service.
- j) Colorado Springs Utilities will not be considered in default of its service agreement and will not otherwise be liable due to failure by Colorado Springs Utilities to perform any obligation if prevented from fulfilling such obligation by reason of delivery delays, breakdowns or damage to facilities, acts of God, public enemy, strikes, or other labor disturbances involving Colorado Springs Utilities or the customer, action of civil, military, or governmental authority or any other cause beyond the control of Colorado Springs Utilities.
- k) The customer may be required to provide a Utilities Addressing Plan (UAP), a Utilities Design CAD File (UDCF) or both in support of a service extension request. Details of the UAP and UDCF are given in Appendix B herein.
- l) When existing customer piping is disconnected from the source of supply (gas meter removed, etc.) in an R-3 occupancy for more than one calendar year, the piping shall be retested in accordance with the requirements of Section 406.4 of the International Fuel Gas Code, 2009

Edition. When existing piping is disconnected from the source of supply (gas meter removed, etc.) in any occupancy other than R-3 for more than six months, the piping shall be retested in accordance with the requirements of Section 406.4 of the International Fuel Gas Code, 2009 Edition.

NOTE: Swimming pool gas meters that have been disconnected are only required to be tested if off for more than one calendar year.

- m) For removal of utilities from a property for demolition or construction purposes, the customer must submit to Colorado Springs Utilities a "Request for Removal of Utilities for Demolition or Construction" (see end of chapter for request form).
- n) Customer owned equipment shall not be physically attached to a Colorado Springs Utilities meter. Any customer equipment found attached to a Colorado Springs Utilities meter will be removed.

1.03 Excavation and Boring Requirements near Utility Lines

- a) [Chapter 3, Article 3 of Part 2 of the City Code \(https://coloradosprings.gov/city-attorney-chief-legal-officer\)](https://coloradosprings.gov/city-attorney-chief-legal-officer) governs excavations in the City and applies to any opening in the surface of a “public place” made in any manner whatsoever. “Public place” is defined to include any public right of way, utility easement, drainage structure, street way, place, alley, sidewalk, park, square, plaza, or any similar public property owned or controlled by the City or Utilities and dedicated to public use, including the location of any electric or gas service line whether on public or private property. This shall include dedicated but not improved streets in new subdivisions. Even though many references are made to the "Code for the City of Colorado Springs", by inclusion in our service standards, and to ensure the health and well-being of the general public, these excavation requirements apply to all excavations around Colorado Springs Utilities' facilities throughout our Dedicated Service Territories.

Any boring operations underneath the surface of a public place are considered excavation upon a public place and are covered by City Code. The City’s requirements for excavation are:

- 1) The first requirement is set out in City Code section 3.3.202 EXCAVATION LICENSE REQUIRED, which provides that “No person shall make any excavation or fill any excavation in any public place without first obtaining a license and permit for the excavation except as otherwise provided in this article”. Pursuant to this section of the City Code, the Deputy Licensing Officer may issue cease and desist orders or initiate license suspension or revocation proceedings against any excavator for a violation of the City Code excavation provisions or of the City's General Licensing Code.
- 2) The second requirement, obtain locations of the underground utilities, is set out in the City Code at section 3.3.211, 3.3.216, and 12.10.104 and by Colorado statute at CRS 9-1.5-101, et. seq. C.R.S. 9-1.5-101, et seq, governs excavation requirements throughout the State of Colorado. That statute requires notification to utility companies and the marking of underground facilities prior to excavation, and provides for civil penalties. The City Code states that no excavation shall take place until location of the facilities has been requested and obtained not more than five working days prior to the excavation. Colorado Springs Utilities must be notified prior to any construction activities around utility lines and or facilities. The proper way to notify Colorado Springs Utilities is through the statewide “One Call” notification system. The statewide “one call” notification system is

the Utility Notification Center of Colorado (Colorado 811) which can be reached at 1-800-922-1987, 811, or at Colorado811.org. Colorado 811 must also be notified of any damages to gas facilities. The Colorado Springs Underground Damage Prevention Safety Program and damage reporting requirements are detailed in City Code Chapter 12, Article 10. Colorado Springs Utilities will bill for the cost of repair to its underground facilities including the cost of gas, electric, or water lost and will assess penalties as allowed under C.R.S. 9-1.5-101, et seq. Colorado statute also requires 911 be notified of any damage that results in a release of gas.

- 3) The third requirement is that one must obtain an excavation permit. City Code section 3.3.204: PERMIT REQUIRED; INSPECTIONS; FEES provides, “A. In addition to the other requirements of this part, no person shall proceed to make or fill any excavation without first obtaining an excavation permit from the City Engineer.”
- 4) The fourth requirement is to follow safe excavation practices for both open trench and trenchless activities. Once the gas locates are complete and an excavator digs within eighteen inches horizontally from the exterior sides of the marked line, per C.R.S. 9-1.5-103 and City Code sections 3.3.211 and 12.10.104, the excavators are required to use non-destructive means of excavation to expose underground facilities such as by hand digging or using soft digging techniques. When using trenchless excavation methods, City Code requires the excavator to visually observe the safe crossing of marked underground facilities (see Table 8 for potholing requirements for private fiber installation using trenchless technologies near gas mains). For additional excavation and damage prevention information, contact Colorado Springs Utilities, Damage Prevention at 719-668-8458.

Additionally, in order to further protect the gas lines, we require the use of a reciprocating tip on hydro-vacuum water wands and not a zero or 30 degree tip, as the zero and 30 degree tips cause excessive damage to utility facilities. The nozzle must be kept 12 inches above utility lines, to prevent damage to the coating, jacket, or material in general.

Any damage to the line must be reported immediately to the Quality Control Supervisor to have the line re-coated or repaired and comply with the requirements of City Code Chapter 12, Article 10. Failure to report damage or numerous damages from negligent work practices will result in charges and penalties as allowed by City Code. Backfill and compaction shall meet City Engineering Public Works specifications.

- 5) Federal OSHA General Requirements 1926.651 B (1) (3) (4) and DOT regulations Part 192 require the protection and separation of underground natural gas lines from other structures, including other utilities (see Table 8 for Clearance Matrix).
- 6) Notify Colorado Springs Utilities at 668-3520 a minimum of three (3) business days in advance to schedule a gas standby appointment. Gas standby appointments are scheduled on a first come first serve basis and a trip fee may be assessed for missed appointments. Gas standby is required 1) prior to exposing any underground gas facility that is four inches (4”) or larger in size or any size facility on the high-pressure distribution system (>76 pounds per square inch gauge (psig)) (potholing addressed separately below), 2) excavating/trenching within 6 feet horizontally of any underground gas facility that is four inches (4”) or larger size pipe or within 10 feet horizontally of any size facility on the high-pressure distribution system , and/or 3) crossing any underground gas facility that is four inches (4”) or larger in size or any size facility on the high-pressure distribution

system (see Table 8 for clearance requirements). Gas standby appointments are also required for potholing on the high-pressure distribution system but not required on the low pressure system when only potholing, unless requested by Colorado Springs Utilities. These activities will be noted with a “Dig Alert (DA)”. Note that with potholing and in order to further protect the coating of gas lines, water pressure shall be limited to 1700 psi around the natural gas infrastructure, dropping to 1200 psi around tar coat pipes which are more susceptible to coating damage.

No more than a maximum of 40 feet of natural gas main or service line may be exposed at a time. At the discretion of Colorado Springs Utilities, Utility Construction and Maintenance Department, Quality Control the exposed footage may be further restricted due to site specific conditions. The exposed span of pipe shall be properly supported and protected from being damaged.

The contractor shall have an adequate amount of approved padding (see Table 7 for Approved Materials) onsite at time of the scheduled gas standby appointment. All Colorado Springs Utilities gas infrastructure that is exposed shall have a minimum of six inches of approved padding sand (see Table 7) placed around the entire circumference of the pipe in the area at which it was exposed and/or crossed in its entirety. No other padding materials are approved, even if only used temporarily.

Potholes must be filled in a timely manner and site cleanup must include the removal of the core. Similar to El Paso County requirements, all core holes must be temporarily filled within 24 hours of being drilled into a hard or soft surface and permanently filled within 7 days of being drilled into the surface. If the core holes need to remain open longer than 24 hours, it is acceptable to cover the holes using a metal plate.

The City has an additional requirement for potholes and requires that non-Utilities personnel filling potholes must do so with flowfill (Colorado Springs Utilities requires 12” of padding above the top of pipe prior to flowfill due to the heat generated. Flowfill in joint trench areas behind curb is not allowed). Contractors working within the City shall also comply with the City’s pothole backfilling requirements. Utilities personnel may use acceptable compaction methods (e.g., pneumatic compactors) to fill potholes and avoid the use of flowfill. No other type of material(s) than what has been approved by Colorado Springs Utilities (see Table 7), even if only used temporarily, shall be used on or around Colorado Springs Utilities gas infrastructure or piping after being exposed when backfilling potholes, excavations, etc.

Directional Drilling Crews and/or Potholing Crews shall use all available resources to locate and expose gas mains and service lines before contacting Colorado Springs Utilities for assistance (note: crews shall comply with standby requirements as described above).

The standards herein are supplementary to, and are not intended to conflict with, the rules and regulations on file with the City Clerk of the City of Colorado Springs or applicable city ordinances.

1.04 Locating Responsibility:

a) Colorado Springs Utilities Locating is responsible to locate:

All gas **mains** on public or private property that are operated and maintained by Colorado Springs Utilities; all gas **service lines** that feed from the gas distribution main extending to the gas meter on residential and commercial properties.

b) Colorado Springs Utilities Locating is not responsible to locate:

Any gas **main** that has been identified as being privately owned; any gas **service** that feeds from the private side of the gas riser and is not owned or maintained by Colorado Springs Utilities.



COLORADO SPRINGS UTILITIES

Customer Contract Administration
2880 International Cir, Suite 210 • Colorado Springs, CO 80910
Phone (719) 668-8111 cca@csu.org Fax (719) 668-8130

Date: _____

REQUEST FOR REMOVAL OF UTILITIES - DEMOLITION OR CONSTRUCTION

Property Address*: _____

**A single application may be submitted for bus shelters, traffic signals or multiple properties of one owner with a separate attachment of additional addresses*

Property Use: Residential Commercial

Property Owner: _____ Phone: _____

Contractor: _____ Phone: _____

Notify Upon Completion of Utilities Removal: Owner Contractor

Notes: _____

Meter #'s: _____

- Requested Services for Removal:
- Electric
 - Transformer
 - Gas
 - Water
 - Wastewater

The Owner/Agent understands and agrees as follows:

Owner/Agent requests that Colorado Springs Utilities' (Utilities) electric, natural gas, water and/or wastewater services servicing the property be disconnected prior to proposed demolition or construction.

_____ (the undersigned) hereby warrants that he/she is the Owner or Duly Authorized Agent of the Owner (either is referred to herein as "Owner/Agent") of the above described property and hereby authorizes Utilities to remove all requested electric, natural gas, water, and/or wastewater services to the above described property and to execute such work as may be necessary to insure the integrity of Utilities' systems and the safety of all concerned. Owner/Agent agrees at his/her expense to meet all Utilities' requirements, including but not limited to those standards and authorized procedures for removal of said utilities. Such standards may be obtained at www.csu.org/business/development/services/utility_specifications.

(The utility removals are typically completed in 5-10 business days; however, emergency service requirements may affect scheduling.)

ELECTRIC

Commercial Electric Service: After Utilities has disconnected service from Utilities' side of the transformer, the Owner/Agent will have a licensed Electrician remove the Commercial Electric service wires from the secondary bushings at the transformer. This must be performed before any construction or demolition activities to protect the secondary bushings from damage.

Residential Electric Service: Utilities will remove the Residential Electric service wires from the transformer.

NATURAL GAS

Utilities will disconnect and cap the Natural Gas service line at or as close as possible to the property line or main.

WATER (Please check one)

Inspections 719-668-3524

Service line to be reused within two (2) years: Any service disconnection and reconnection must follow Utilities' Line Extension and Service Standards.

Service line not to be reused: If the water service line is not to be reconnected or reused, then the water service line and tap shall be removed by Owner/Agent back to the water main in accordance with Utilities' Line Extension & Service Standards for Water. If Utilities is required to remove the service line and tap, Utilities will invoice the Owner for all removal costs and main line repairs on a time and materials basis; and Owner/Agent will pay any such invoice within thirty (30) days of receipt.

Inspection fees will be paid by the Owner/Agent to Utilities in accordance with Colorado Springs Utilities' Tariff

WASTEWATER (Please check one)

Inspections 719-668-3524

Service line to be reused within (2) years: If the wastewater service line will be reconnected, Owner/Agent will have a Licensed Excavator remove and cap (water tight) the wastewater service line in compliance with Utilities' Line Extension and Service Standards and may require CCTV inspection to confirm the integrity of the service line.

Service line not to be reused: If the wastewater service line is not reconnected or reused, then the wastewater service line and tap shall be removed by Owner/Agent back to the wastewater main. If Utilities is required to remove the service line and tap, Utilities will invoice the Owner/Agent for all removal costs and wastewater main line capping on a time and materials basis; and Owner/Agent will pay any such invoice within thirty (30) days of receipt.

Inspection fees will be paid by the Owner/Agent to Utilities in accordance with Colorado Springs Utilities' Tariff

F01-00778 (08/2019)

GENERAL PROVISIONS

The term "reconnection" as used in this Request for Removal of Utilities applies only when no alterations to the existing service connection points are required either by Owner/Agent or by current Utilities' Line Extension and Service Standards. If for any reason it should become necessary to reinstall or reconnect any of the utility services that have been disconnected pursuant to this Request for Removal of Utilities or if such services later appear to have been wrongfully removed or discontinued at the Owner/Agent's request, the Owner/Agent agrees to indemnify and hold harmless Colorado Springs Utilities from any and all claims arising from the removal or discontinuance of said services and to promptly reimburse Colorado Springs Utilities for any and all costs or expenses incurred to reinstall or reconnect such services and any other applicable fees. Colorado Springs Utilities shall not be liable for delays in performing its obligations to the extent the delay is caused by an unforeseeable condition beyond its reasonable control without fault or negligence including strikes, riots, wars, floods, fires, explosions, acts of nature, or labor disturbances. This Request for Removal of Utilities is subject to the applicable provisions of the City Charter, City Code, ordinances, rules and regulations of the City of Colorado Springs as amended as well as applicable provisions of Colorado Springs Utilities' Tariff, as now in effect or hereafter amended. The laws of the State of Colorado will govern this Request for Removal and any interpretation or construction thereof. Owner/agent acknowledges that Colorado Springs Utilities is afforded protections of the Colorado Governmental Immunity Act, C.R.S. §24-10-101, *et seq.*

Additional Fees: Owner/Agent understands that there may be additional fees to reconnect utility service to the above described property and will pay any fees required.

Owner/Agent Signature _____ Address _____

State of Colorado)
County of El Paso)

Subscribed and sworn before me this _____ day of _____ 20____, By _____
(Printed name of owner/agent)

Notary Public My commission expires: _____

Application may be submitted electronically, by mail or in person.

<i>(For Colorado Springs Utilities Completion)</i>	
Premise ID: _____	
Additional Information: _____	

<input type="checkbox"/> Electric Primary: _____	Date: _____
<input type="checkbox"/> Electric Service: _____	Date: _____
<input type="checkbox"/> Natural Gas Service: _____	Date: _____
<input type="checkbox"/> Water Service: _____	Date: _____
Place of removal: <input type="checkbox"/> _____ <input type="checkbox"/> Water main	
<input type="checkbox"/> Wastewater Service: _____	Date: _____
Place of removal: <input type="checkbox"/> _____ <input type="checkbox"/> Wastewater main	
<input type="checkbox"/> Complete Demolition ONLY :	
Email sent to LBS – 'WRECK' old address: _____	Date: _____
Completed and Customer Contacted: _____	Date: _____

F01-00778 (08/2019)

NATURAL GAS CUSTOMER BURIED PIPING SAFETY NOTICE

Colorado Springs Utilities is committed to providing safe reliable service to our customers. We own, operate and maintain all natural gas piping, from the pipe located beneath streets, sidewalks and yards to the meter. In accordance with federal pipeline safety regulations, this notice is to inform customers of their responsibility for the gas piping installed past the gas meter.

Some examples of buried customer gas piping **not** maintained by Colorado Springs Utilities are:

- Buried piping past the outlet of a meter supplying mobile homes;
- Buried piping past the outlet of a meter supplying secondary buildings (e.g., detached garage and workshops);
- Buried piping past the outlet of a meter supplying additional equipment (e.g., gas grill and yard lamps).

In most cases, the gas meter is installed at the wall of the primary structure resulting in no buried piping.

If you have buried customer piping, be advised of the following:

- Buried piping that is not maintained may be subject to the potential hazards of corrosion and leakage.
- Buried piping should be:
 - Periodically inspected for leaks;
 - Periodically inspected for corrosion if the piping is metallic;
 - Repaired or removed from service if any unsafe condition is discovered. Repairs should be performed by a professional; contact a licensed plumbing contractor to perform inspections or make repairs to buried plumbing.
- Before excavating near buried piping, the piping must be located in advance, and excavation done by hand.

Natural gas customers are encouraged to have their buried piping reconfigured and replaced and have the meter relocated by Colorado Springs Utilities. All costs associated with the piping reconfiguration and replacement is the responsibility of the customer or property owner. Once the reconfiguration and replacement is complete, Colorado Springs Utilities would then be responsible for maintaining the buried piping.

For your safety, remember to call 811 before digging to have utilities marked.

If you have any questions regarding this notice, please call us at 719-448-4800.

TABLE OF CONTENTS

CHAPTER 2

Gas Main/Service Stub Extension

Paragraph Number	Title	Page Number
2.01	Introduction	2-2
2.02	Application	2-3
2.02 a)	Required Plans	2-3
2.02 b)	Private Streets	2-3
2.02 c)	Location & Clearances of Gas Main Lines	2-3
2.02 d)	Easements	2-6
2.03	Design and Estimate.....	2-6
2.04	Execution of Extension Contract	2-7
2.05	Construction.....	2-7
2.05 a)	Construction Scheduling	2-7
2.05 b)	Frost Processes.....	2-9
2.05 c)	Gas Crossings	2-9
2.05 d)	Request for Colorado Springs Utilities to Work Overtime	2-10
2.05 e)	Main Line Relocation.....	2-11
2.06	Final Costs & Execution of Refund Contracts	2-11
2.07	Assignment of Contracts	2-11
2.08	Refund Contracts	2-11
2.08 a)	Single Parcel Refund Contract.....	2-11
2.08 b)	Mainline Facilities Refund Contract.....	2-11
2.09	Refunds.....	2-12
2.09 a)	Revenue Based Refunds.....	2-12
2.09 b)	Load Based Refunds	2-12
2.10	Installation of Service Lines	2-12

Example Applications & Contracts:

Application for Gas and Electric Line Extension.....	2-13
Application for Elevated Pressure Approval.....	2-14
Application for Gas Service Line Approval.....	2-15
Colorado Springs Utilities Non-Standard Gas Meter Loop Agreement.....	2-16
QC Inspection Sheet	2-17
Utility Staking Standards (New Residential & Commercial)	2-18
Utility Staking Standards (Verification Form).....	2-19
Economically Feasible Extension Contract	2-20
Extension Contract (Not Economically Feasible)	2-23
Single Parcel Refund Contract	2-27
Mainline Facilities Refund Contract.....	2-30
Request Form for Colorado Springs Utilities to Work Overtime	2-33
Frost Approval Form	2-34

CHAPTER 2

Gas Main/Service Stub Extension

2.01 Introduction

This chapter explains the process for extending gas main lines and service stubs to sites within the Colorado Springs Utilities Gas Certificated Service Territory and covers the steps an Applicant will go through when requesting a main line extension. The chapter also explains Colorado Springs Utilities current extension and refund policies and associated extension and refund contracts as provided for in the Natural Gas Tariff. The application forms, sample contracts, and refund calculations can be found at the end of this chapter.

The process for extending gas service includes the following steps:

- a) Submittal of **Application for Gas & Electric Line Extension** including required plans and information requested on application form
- b) Preparation of **Design** and **Cost Estimate** by Colorado Springs Utilities Field Engineering Staff
- c) Determination of type and preparation of Extension Contract with specified Design Fee
- d) Execution of **Extension Contract** by Applicant
- e) **Construction** by Colorado Springs Utilities
- f) Execution of **Refund Contract** by Applicant, *only if* Extension Contract is determined to not be economically feasible by Colorado Springs Utilities
- g) Installation of **Service Lines** by Licensed Utility Service Installer (LUSI)
- h) **Meter Set** installations by Colorado Springs Utilities
- i) **Refunds** by Colorado Springs Utilities

The line extension process begins when the Applicant submits an **Application for Gas & Electric Line Extension** and all required plans and information to Field Engineering. Colorado Springs Utilities then prepares a design and estimate, and notifies the Applicant of the estimated cost of construction plus the specified, non-refundable, design fee. The Utilities Rules and Regulations detail the cost allocation of mainline facilities. Contracts for economically feasible extensions, as determined by Colorado Springs Utilities, will require the advancing of a percentage of the total estimated extension cost plus the specified design fee, as a non-refundable payment as described in the current tariff. The Applicant will remit the non-refundable sum and execute the Extension Contract. No Refund Contracts will be executed on economically feasible extensions. All other Applicants will advance 100 percent of the estimated cost of construction to Utilities plus the specified non-refundable design fee and execute the Extension Contract. After completion of construction, Colorado Springs Utilities will determine the actual costs of construction and either charge (or refund without interest) the difference between the estimated

and actual costs of construction. Once all amounts due to Colorado Springs Utilities are paid, the Applicant will be entitled to execute a Refund Contract. Colorado Springs Utilities constructs the gas mains, service stubs and associated facilities. The Builder contracts with a LUSI to construct the service lines from the service stubs to the buildings (i.e. on the Applicant's private property). The gas meter is set, and Colorado Springs Utilities refunds the Applicant for each new meter set (i.e. new service connection) under the terms of the executed Refund Contract.

2.02 Application

The Applicant initiates the line extension process by submitting an **Application for Gas & Electric Line Extension**, as well as the required plans for design and construction. The application is a standard form provided by Field Engineering that captures pertinent information about the Applicant and the requested extension. A copy of the Application is included at the end of this chapter and online at www.csu.org/Pages/development-files-forms.aspx.

a) Required Plans:

Along with the application, the Applicant must submit the following plans: water plans, street plans and profiles showing the location and elevation of sanitary and storm sewer lines, service stub plans showing the planned location of utility service stub lines into each lot, and a recorded plat. The Applicant may submit a request without a recorded plat. However, construction will not begin until the Applicant has submitted a recorded plat or an appropriate easement document granting the required right-of-way to Colorado Springs Utilities.

Please Note: Unless the Applicant is extending gas service in existing streets, a **Utilities Addressing Plan (UAP) and/or Utilities Design Cad File (UDCF) must be submitted to the Colorado Springs Utilities Facility Information Management Systems (FIMS) Office before any action will be taken on a line extension request.** The UAP/UDCF requirements are included in Appendix B of this document. For more information about UAP/UDCF, please call the Colorado Springs Utilities FIMS office (see Phone Section).

b) Private Streets:

For projects with private streets, including most apartment, condominiums, townhouse and commercial projects, the Applicant must also submit site development plans, master facilities plans, and landscaping plans. The Applicant should also pay special attention to the separation requirements discussed in 2.02(c) "Location of Gas Main Lines", since private streets are typically narrower and thus more challenging to provide required utility separations.

c) Location & Clearances of Gas Lines:

The location of water, electric, sanitary sewer, storm sewer and other underground facilities must provide adequate separation for gas facilities (see Table 8 for Clearance Matrix; See 4.03c for additional Service Line Clearances). At time of installation, typical depths of gas main lines are installed, from top of pipe to grade, between 30 inches minimum and 48 inches maximum for ≤ 76 pounds per square inch gauge (psig) gas mains, and between 48 inches minimum and 72 inches maximum for the high-pressure distribution system (>76 psig).

1) Gas main lines (≤ 76 psig) shall have the following minimum separations:

- a) Minimum 6 foot horizontal separation when installed parallel to other utilities and structures.

EXCEPTION: Hillside Minor Residential Streets – Minimum 5 foot horizontal separation.
 - b) Minimum one foot of vertical separation when crossing other utilities.
 - c) Minimum one foot radial separation when gas, electric, and communication lines are approved to be in the same trench.
 - d) Minimum 30 inches of cover required.
 - e) Minimum 6 foot horizontal separation for trees [see c)3) below].
- 2) High-pressure distribution system main lines operated at >76 psig must have the following separations. Rare exceptions to the below must be approved by Colorado Springs Utilities, Utility Construction and Maintenance Department:
- a) Minimum 10 foot horizontal separation when installed parallel to other utilities.
 - b) Minimum 15 foot horizontal separation with structures.
 - c) Minimum 5 foot vertical separation when crossing other utilities.
 - d) Minimum 10 foot horizontal separation from trees [see c)3) below].
 - e) Minimum 4 foot cover required.
- 3) Gas lines (mains and services) shall have the following minimum separation with trees:
- a) Trees may not be planted within 10 feet horizontally of the high-pressure distribution natural gas system (>76 psig) and within 6 feet of a natural gas system (\leq 76 psig gas main or service) with limited exceptions listed in the Time of Landscape Plan Approval table below. Exceptions that allow planting of shallow root medium/small species shall use the Approved Street Tree with Shallow Roots table. The horizontal separation distance is measured from the base of the tree to the gas pipe.
 - b) When dead trees are replaced per the below table, buried utilities must be located pursuant to Chapter 12 Article 10 of Colorado Springs City Code prior to removing the dead trees and planting the replacement species.
 - c) Standby requirements (see Section 1.03) apply to activities within 6 feet of a gas pipe that is four inches (4") or larger in size or any size facility on the high-pressure distribution system (>76 psig). In addition to standby requirements, potholing is required when activities are within 6 feet of a gas pipe. These requirements must be met during tree planting/removal/replacement activities.
 - d) If excavation will occur within 18" from either side of the exterior sides of any marked utility regardless of size, the marked utility must be exposed by **potholing** using non-destructive & non-mechanical means of excavation. Examples: shovel, hand tools, water or air vacuum methods.
 - e) New or replacement trees, if permitted per the below table, shall have a minimum 1 foot vertical/radial separation between the bottom of the root ball and the gas pipe.

The gas pipe must be potholed and visually observed to ensure this vertical separation between the gas pipe and the bottom of the root ball.

	Time of Landscape Plan Approval¹		
	Pre-2017	2017-2021	2022 and Forward
<p>Plant new tree where none existed prior</p> <p>(Note: For all lots regardless of when constructed, no trees are permitted within 10 feet of the high-pressure distribution system.)</p>	<p>Unless shown on a pre-2017 approved Landscape Plan (not expired), new trees shall not be planted within 6 horizontal feet of a natural gas pipe. If the exception applies, it is highly recommended they are planted 6 feet away from the gas pipe or use shallow root medium/small species</p>	<p>New trees shall not be planted within 6 horizontal feet of a natural gas pipe unless shown on a pre-2021 approved Landscape Plan (not expired), which will require shallow root medium /small species</p>	<p>New trees shall not be planted within 6 horizontal feet of a natural gas pipe² unless shown on a pre-2022 approved Landscape Plan (not expired), which will require shallow root medium/small species</p>
<p>Replacement tree</p> <p>(Note: For all lots regardless of when constructed, no trees are permitted within 10 feet of the high-pressure distribution system)</p>	<p>It is highly recommended that replacement trees for trees originally planted per an approved Landscape Plan are planted 6 feet from the gas pipe or with a shallow root medium /small species in the same location.</p>	<p>It is highly recommended that replacement trees for trees originally planted per an approved Landscape Plan are planted 6 feet from the gas pipe. If replacement trees are planted within 6 feet of the gas pipe, it is required that they be planted in the same location as the prior tree and must be shallow root medium /small species.</p>	<p>Not applicable (if Landscape Plan approved prior to 2022, see adjacent columns).</p>

¹ The Landscape Plans referenced shall be reviewed and approved by City Planning. These Landscape Plans are a City requirement for development projects, to include commercial projects and residential subdivisions (common spaces and right of way (ROW)). If approved projects have not been built, the Landscape Plan expires in 6 years. If a project is constructed, the approved Landscape Plan never expires. Individual Single Family Residential lots do not have City specific tree species requirements unless planted in the ROW. Commercial lots have Landscape Plans and specific tree species over the last 20 plus years. Landscape Plans older than that may not have specific tree species requirements.

² Joint trench gas mains/services will be typically located under sidewalk and thus protected. In instances where they not located under a sidewalk, protection is provided via the 6 or 10 feet of separation.

Approved Street Tree with Shallow Roots List			
Approved Medium Trees (25-45 ft)		Approved Small Trees (< 25 ft)	
Amur corktree (<i>male only</i>)	<i>Phellodendron amurense</i>	Amur chokecherry	<i>Prunus maackii</i>
Golden raintree	<i>Koelreuteria paniculata</i>	Newport plum	<i>Prunus cerasifera</i>
Japanese pagoda (<i>protected site</i>)	<i>Styphnolobium japonicum</i>	Princess Kay plum	<i>Prunus nigra</i>
Japanese tree lilac (<i>protected site</i>)	<i>Syringa reticulata</i>	Tatarian maple	<i>Acer tataricum</i>
Bigtooth maple (<i>single stem only</i>)	<i>Acer grandidentatum</i>	Amur maple	<i>Acer ginnala</i>
Maple, Miyabe/ State Street	<i>Acer miyabei</i>		
Mountain ash	<i>Sorbus aucuparia</i>		
Ohio buckeye	<i>Aesculus glabra</i>		
Ussurian pear (<i>fruitless only</i>)	<i>Pyrus ussuriensis</i>		
Turkish filbert	<i>Corylus colurna</i>		

Note: Approved Street Tree List for Colorado Springs updated by City Forestry in Oct 2019. The list provided above is a subset of the City’s Steet Tree List and includes those with shallow rooting habits. Plant substitutions due to lack of plant availability or seasonal planting constraints may be considered with approval from City Planning and Colorado Springs Utilities, Utility Construction and Maintenance Department.

d) Easements:

Service lines are considered a condition of service as allowed by the Utilities Rules and Regulations and easements may not be required. It’s more typical for easements to be required for distribution systems in private streets or right-of-ways. However, City Code (12.3.303) requires that Colorado Springs Utilities determines the location or locations at which any owner service line shall be connected to the gas distribution system and that the connection shall be made without entering upon property other than the property of the owner so connected, unless an acceptable recorded utility easement is provided.

The Applicant must submit an acceptable utility easement for private streets and right-of-ways. A standard easement document form is available online at www.csu.org/Pages/development-files-forms.aspx, or through Colorado Springs Utilities Field Engineering, and should be submitted with the line extension application as necessary.

The easement widths for underground utilities can vary based on the number of utilities installed in a given area, the size of the utility lines, depth of utilities, multiple utility infrastructure of the same designation (e.g., gas with gas), construction methods, and the pressure of the gas lines. Typical gas only easements are a minimum of 50 feet for a gas main that is part of the high-pressure distribution system and a minimum of 20 feet if part of the less than or equal to 76 psig system and if joint gas/electric trench. Colorado Springs Utilities Field Engineering, with input from Colorado Springs Utilities, Utility Construction and Maintenance Department, will determine the necessary easement required based on site and project specific variables.

2.03 Design and Estimate

Upon receipt of the **Application for Gas & Electric Line Extension** and all required plans, Colorado Springs Utilities will begin designing the new gas facilities and estimating the cost of installing these facilities. There will be a specified design fee assessed for this work. Any

variations to gas facility designs that are requested different from Colorado Springs Utilities current design standards and specifications (e.g., GLESS, Natural Gas Design and Engineering Manual, etc.) will be reviewed to ensure they meet or exceed existing design requirements. If approved, the costs for the variations are charged 100% to the customer with the estimate to be determined at the time of the request and all final costs being reconciled at the end of the project.

Projects are prioritized for design according to how close they are to being ready for construction of gas facilities. Gas facilities are installed in a joint trench with electric or after all other utilities are installed and the curb and gutter is constructed. Application for line extensions should be made as early as possible in the development process to assure adequate time for design and estimate.

2.04 Execution of Extension Contract

After the design and estimate are completed, the Applicant receives copies of each, plus a copy of the applicable Extension Contract along with a letter requesting execution of the contract and remitting either the percentage of the estimated cost of construction, as described in the current tariff, plus the specified design fee or 100 percent of the estimated cost of construction plus the specified design fee to Colorado Springs Utilities. The estimated cost of construction for oversized facilities is based on a nominal pipe size. The Extension Contracts detail the terms under which the new gas facilities will be constructed. Samples of both Extension Contracts are included at the end of this chapter.

2.05 Construction

Gas mains and service stub facilities may be constructed only by Colorado Springs Utilities or by Colorado Springs Utilities gas contractor. The onsite geotechnical company, developer, or the developer's representative shall be responsible for promptly and consistently providing a copy of all completed soil compaction test results that are taken on any and all new construction projects where the gas and/or electric utilities are or have been installed by Colorado Springs Utilities or its designated contractor. The frequency of density tests shall be a minimum of every 250 linear feet of gas / joint / electric mainline trench and at each service stub installed. The number of density tests may be increased if directed by the Colorado Springs Utilities Gas Construction Quality Control Inspector. If flowable fill is installed compaction and density tests are not required. These soil compaction test results shall be furnished to the onsite Colorado Springs Utilities Gas Construction Quality Control Inspector immediately upon the completion of said soil compaction tests and prior to the installation crew leaving and/or moving off the development, subdivision, or jobsite. This is to ensure that any soil compaction test failures or issues that may exist can be remedied prior to the crew moving off or leaving the jobsite.

a) Construction Scheduling:

Construction of new gas facilities is scheduled after the Applicant has executed an Extension Contract, remitted the appropriate fees and prepared the site for construction. The site is considered ready for gas facility construction after all other utilities are installed, and curb and gutter is constructed. Colorado Springs Utilities, Utility Construction and Maintenance Department must approve construction if curb and gutter is not constructed.

NOTE: The customer (developer or representative of the project) is responsible for providing locates for all private utilities not belonging to Colorado Springs Utilities.

Construction scheduling is done weekly by Colorado Springs Utilities and is based on field status reports. It is imperative that the Applicant provide construction status updates to Colorado Springs Utilities during the course of a project to ensure proper design and construction prioritization. If Colorado Springs Utilities crews are delayed due to the construction site not being ready to install facilities after mobilizing to the site, the developer will be charged for the cost of de-mobilizing and re-mobilizing to the site with a Time and Material contract. Construction updates can be provided to Construction Scheduling (see Phone Section).

Prior to scheduling and installation of gas facilities, Colorado Springs Utilities must receive full payment and the customer must meet the following conditions:

- 1) Final grade will be provided within +/-3" at any electric vault, cabinet, transformer, or junction box (J-Box) and within 6" whether curb & gutter or grade stakes are installed.
- 2) Installation of curb & gutter, excluding curb returns. As an option, Colorado Springs Utilities will consider working from curb stakes with final grade and/or finished grade clearly marked. The entire project will have curb & gutter or staking for curb & gutter. However, no combination of curb & gutter and staking will be approved unless a Colorado Springs Utilities Gas Construction Quality Control Inspector deems extenuating circumstances exist and it is necessary to move a project forward. The developer and a Colorado Springs Utilities representative will be required to sign a "Utility Staking (Verification Form)" before the project is energized. This form will be provided by the construction crew or the quality control inspector. Signatures on this form verify that the gas facilities have been correctly installed relative to the curb stakes and the grade stake references (see Utility Staking forms at the end of this chapter). It is the developers responsibility to confirm correct staking 24 hours in advance of crew installation activities to ensure staking has not been altered. The developer will incur all costs for improper installation or repositioning of facilities, due to staking errors, staking alterations, or changes in grade.
- 3) All property pins will be provided. Should these pins be inadvertently removed during construction, it is the responsibility of the customer to replace them.
- 4) Installation of all electric (unless in joint trench), water and wastewater mains and service stubs, storm drains, and catch basins with trenches associated with these facilities backfilled and properly closed.
- 5) All trash, construction material, debris, and fences cleared from the proposed gas construction site or path.
- 6) Certified soil density tests when requested. Developer must provide Colorado Springs Utilities or its agents a copy of all compaction test results taken on utility trenches.
- 7) The installation of the following facilities is preferred after gas:
 - f) Sidewalks
 - b) Driveways and curb returns

b) Frost Processes:

1) Gas Only Project:

Monies paid per the Tariff to dig in frost will not be refunded as part of any single parcel or mainline contract. Utilities crews must complete the “Payment Itemization” sheet and Utilities’ contractors should use the appropriate frost bid units for digging in frost. Field Engineering will reconcile the costs after the project construction is completed. Developers that choose to dig the ditch during frost conditions must complete the Frost Approval Form and follow the process detailed in the form. The cost will be absorbed by the developer and the contracts will be reconciled to show the appropriate ditching units.

2) Joint Trench Projects:

Joint Trench projects will be administered under the following rules and regulations:

Installation of the primary conduit and conductors, transformer pads, vaults, and service conductor will be installed by Colorado Springs Utilities. At the discretion of Colorado Springs Utilities, the customer may be required to furnish all necessary trenches, excavations and backfill to meet standards set forth by Colorado Springs Utilities. A credit will be given based on average trenching costs to Colorado Springs Utilities in average soils. Colorado Springs Utilities will, in these cases, select the backfill to cover all conductors. If the excavated material contains rock, it will not be satisfactory for backfill and the customer will be required to supply proper fill material and compaction. Any alterations or relocation of the underground electrical lines as installed in said subdivision will be done at the customer’s expense.

c) Gas Crossings:

Special Conditions for Gas Crossings– **ONLY Designed Joint Trench Projects:**

1) Definitions:

- a) Gas Carrier Pipe** – gas piping installed and used to transport natural gas.
- b) Gas Crossings** – gas carrier pipe installed at street crossings.

2) Colorado Springs Utilities prefers to have all gas facilities installed using “normal” installation procedures. Normal installation procedures are when the following occur in sequence:

- a) Wet utilities and storm systems are installed;**
- b) Curb and gutter is installed, or approved staking is in place;**
- c) Gas Carrier Pipe is installed from beginning to end of project *and is energized;* and**
- d) First lift of asphalt is laid and/or street is paved.**

- 3) Developers will be charged if the first mat of asphalt is laid before a Colorado Springs Utilities crew arrives. Work that Colorado Springs Utilities crews are required to perform for asphalt removal and related tasks will be billed to the Developer. Billed charges will include the cost for saw cutting, trench removal, material removal from the job site (if not left onsite), and restoration services needed upon job completion.

If the Developer decides to have Colorado Springs Utilities install gas crossings after the final lift of asphalt is laid or after the installation of roadway stabilization, such as Soil Cementing, Colorado Springs Utilities will directional bore the gas crossing during the standard scheduled crew installation. The cost for the boring will be estimated and applied to the Mainline Extension contracts at the time of the design.

The use of sleeves for crossings is not allowed, due to safety and maintenance issues. A gas leak can be difficult or impossible to detect and locate with leak search equipment, and gas would be forced onto customer properties. In addition, sleeves do not allow pipe closure for repairs.

d) Request for Colorado Springs Utilities to Work Overtime:

Developers or other customers may request for a Gas or Electric Extension Crew (Colorado Springs Utilities/Contractor) to work overtime (OT) on their projects. Colorado Springs Utilities reserves the right to select the crew based on operational and contractual obligations.

The Developer or other customer must submit to Colorado Springs Utilities Field Engineering a T&M Overtime Request Letter with relevant information filled in (see form at the end of this chapter). These request letters are also available from Colorado Springs Utilities Gas Construction Quality Control Inspectors, Colorado Springs Utilities Crew Supervisors or Colorado Springs Utilities Field Engineering representatives. If an overtime request is approved (contingent upon crew availability), Colorado Springs Utilities Field Engineering will create a Flat Rate T&M contract.

All monies for OT work that is requested and approved must be collected before construction can start, without exception. The Developer or customer must know and make payment for hours of OT the crew will work. There will be no reconciliation after the project and crews will only work for hours paid in full. Therefore, the precise number of hours to be worked needs to be known at the time of the request.

Field Engineering can supply the hourly crew rate (adjusted annually in May) that will cover the total labor rate for the crew to include typical equipment used.

If special conditions exist that require extra personnel or specialized equipment for construction, Colorado Springs Utilities Field Engineering may apply additional charges to the flat rate.

The money received by Colorado Springs Utilities Field Engineering will be deposited as Aid to Construction at the respective Field Engineering office. Contact Colorado Springs Utilities Field Engineering with questions (see Contact Section).

e) Main Line Relocation:

Any relocation of main lines required due to customer actions is charged to the customer on a Colorado Springs Utilities T&M basis (Example: grade changes, new buildings/structures which jeopardize existing gas main lines). Relocation costs charged to the customer would also include any costs for environmental issue abatement as well as proper abandonment and pipe removal per Colorado Springs Utilities procedures. T&M contracts are initiated by Colorado Springs Utilities Field Engineering Section. Upon completion, the contract will be reconciled for actual costs.

In the case of any requested vacation of easements, all identified and unknown environmental issues must be addressed at the cost of the requesting customer prior to vacation.

2.06 Final Costs & Execution of Refund Contracts

After the new gas facilities are constructed and the actual cost of construction is calculated on projects that are not considered economically feasible, the Applicant receives a copy of the Refund Contract accompanied by a letter notifying him/her of the actual cost of the extension and requesting him/her to execute the Refund Contract. If the actual costs are greater, the Applicant must remit the difference to Colorado Springs Utilities along with the Refund Contract. If the actual costs are less, the Applicant receives a refund for the difference after the Refund Contract is executed.

2.07 Assignment of Contracts

Under the terms of the Refund Contract, all refunds will be made directly to the Applicant unless the Applicant executes an acceptable assignment document.

2.08 Refund Contracts

Developer to check box located on the Application for Gas and Electric Line Extension form to request applicable Gas Mainline Facilities Refund Contract.

a) Single Parcel Refund Contract:

The most common type of Refund Contract is the Single Parcel Refund Contract (see example form at the end of this chapter). Single Parcel Contracts cover the actual cost of installing mains and service stubs to serve a subdivision or parcel. Single Parcel Contracts allow for part or all of the advanced payment to be refunded to the Applicant through revenue based refunds. The term of these contracts is ten years.

b) Mainline Facilities Refund Contract:

The other type of Refund Contract is the Mainline Facilities Refund Contract (see example form at the end of this chapter). Mainline Facilities Contracts cover the actual cost of an extension that serves areas not contiguous with existing gas systems, or the cost of system reinforcements to serve a customer directly from the high-pressure distribution system (>76 psig), or to serve a single customer. Mainline Facilities Contracts allow for part or all of the

advanced payment to be refunded to the Applicant through load based refunds. The term of these contracts is twenty years.

2.09 Refunds

For the term of the Refund Contract, refunds are made to the Applicant after meters are set and placed in service (see example refund calculations at the end of this chapter).

a) Revenue Based Refunds:

Revenue based refunds, for Single Parcel Refund Contracts, are determined from estimated annual revenue generated by new service connections. The estimated annual revenue is determined at the time of connection, and is based on the estimated load and the service rate at the time of connection.

1) Loads greater than 5,000 cubic feet per hour (cfh):

Revenue based refunds for connections with loads greater than 5,000 cfh are based on actual rather than estimated revenues. An estimated refund amount is determined at the time of connection and 50 percent of that amount is processed for refund. One year after the connection, the final refund amount is determined based on actual revenues from that period. An adjustment refund is made for the difference.

b) Load Based Refunds:

Load based refunds are made for Mainline Facility Refund Contracts. The refund amount for new services connected under a Mainline Facility Contract is equal to the ratio of the connected (estimated) load to the design load, multiplied by the Applicant's portion of the cost of the new facilities (original Mainline Facilities Contract amount). The design load of the Mainline Facility is determined in the design process and is included in the Mainline Facility Refund Contract.

2.10 Installation of Service Lines

The property owner is responsible for the cost of installation of the gas service line on his/her private property. The cost of this installation is not included in the Refund Contract and thus is not eligible for refund. Polyethylene service lines greater than 2 inches in diameter and all steel service lines are to be installed only by Colorado Springs Utilities under a Time and Materials Contract. Polyethylene service lines less than or equal to 2 inches in diameter shall be installed by Colorado Springs Utilities or LUSIs under contract with the property owner. For an updated list of LUSIs call the Colorado Springs Utilities, Utility Construction and Maintenance Department (see Phone Section). Refer to 4.03(b) for more details about the location at which the service lines shall be installed.



Gas Work Order # _____
Electric Work Order# _____
(Internal Use)

APPLICATION FOR GAS AND ELECTRIC LINE EXTENSION

(Residential Electric - Residential and Commercial Gas)

To be submitted to: UtilityApplication@csu.org or

North Work Center Field Engineering **South Work Center Field Engineering**
7710 Durant Drive, P.O. Box 1103, Mail Code 2150 or 1521 Hancock Expressway, P.O. Box 1103, Mail Code 1812
Colorado Springs, CO 80947-2150 Colorado Springs, CO 80947-1812

Project: _____ **Date:** _____
(Subdivision, address, or description of project)

Applicant: _____
(Entity that will enter into contract) Individual Partnership Corporation Limited Liability Company Other

This application is intended for: Gas Electric Both **Avg. Building Sq. Footage?** _____

Will there be any "Parade / Model" homes built within this project? Yes No
Will the first lift of asphalt be installed prior to the construction of utilities? Yes No
Will this project use soil cementing in the roadways? Yes No

Projected date that site will be ready for gas and/or electric installation _____

If an applicant advances funds for construction of Gas Mainline Facilities, they may receive refunds for that facility. The Applicant must notify Colorado Springs Utilities prior to the start of construction if the Applicant desires to enter into a Refund Contract. Please check box to request applicable Gas Mainline Refund Facilities Co ct []
Note: a meter will not be installed until the person financially responsible for the billing has set up an account with Utilities Development Services (719-668-8111).

PLAN REQUIREMENTS (2 sets if submitting for both gas and electric)

- Water System Plan Wastewater System Plan & Profile Utilities Addressing Plan (UAP)*
 - Street Plan & Profiles Storm Drain Plan & Profile Utilities Design CAD File (UDCF)*
 - Utility Service Plan Recorded Plat or Utility Easement Gas loads per building (if commercial)
- * See requirements in Appendix B of the Colorado Springs Utilities Line Extension and Service Standards

Applicant agrees to provide Colorado Springs Utilities with a recorded plat or acceptable easements prior to construction. The Applicant agrees to notify Colorado Springs Utilities of any changes following submittal of application that may affect the design, scheduling, and construction of the gas and electric distribution system.

Applicant's Signature (Contract holder)

Agent's Name (Project Contact)

Applicant's Name (Please type or print)

Address

Address

City, State, and Zip Code

City, State, and Zip Code

Telephone and FAX Numbers

Telephone and FAX Numbers

Cellular/Field Numbers (If Applicable)

Email Address

Email Address

Please indicate who the Designs, and Contracts should be sent to: **Applicant** **Agent**

Applicant's Signature Authorizing the **Agent** to sign contracts and bind Applicant to such contracts regarding gas and electric.

07/25/23



APPLICATION FOR ELEVATED NATURAL GAS PRESSURE APPROVAL

Please fill out all applicable lines, including reason for request. Elevated pressure requests over 2 psig must include documentation from equipment manufacturer showing need for requested pressure.

Location:

Facility Name _____

Street Address _____

Applicant:

Applicant Name _____ Phone _____

Company Name _____ Phone _____

Mailing Address _____

City _____ State _____ Zip _____

Applicant Email _____

Plumbing Co:

Company Name _____ Phone _____

Email Address _____ License Number _____

Facility:

Existing Natural Gas Load _____ BTUH at _____ psig Delivery Pressure

Proposed Natural Gas Load _____ BTUH at _____ psig Delivery Pressure

Note reason for elevated pressure request _____

Signature _____ Date _____

Request cannot be completed without signature.

Email the completed request to UtilityApplication@csu.org or as an alternate, send completed request to appropriate Field Engineering Office (North Work Center handles gas).

North Work Center
7710 Durant Drive
PO Box 1103, Mail Code 2150
Colorado Springs, CO 80947-2150
Phone: (719) 668-4985
Fax: (719) 668-4998

South Work Center
1521 Hancock Expressway
PO Box 1103, Mail Code 1821
Colorado Springs, CO 80947-1821
Phone: (719) 668-5564
Fax: (719) 668-5956

For Office Use Only

Work Order Number(s) _____

FE _____ Phone _____



APPLICATION FOR NATURAL GAS SERVICE LINE APPROVAL

This form is to be used when requesting a new natural gas commercial service with any load, a new residential natural gas service for any load over 1,000,000 BTU, any service where there is no stub to the property line, or a change to existing gas load. Please fill out all applicable information.

Location:

Facility Name _____
Street Address _____

Applicant:

Applicant Name _____ Phone _____
Applicant Email _____

Plumbing Co:

Company Name _____ Phone _____
Mailing Address _____
City _____ State _____ Zip _____
Email Address _____ License Number _____

Facility: Existing Gas Load: _____ BTUH
Proposed Gas Load: _____ BTUH

*Note: Our standard delivery pressure is 0.25 psig (7" W.C.). If a greater pressure is needed, submit an Application for Elevated Natural Gas Pressure Approval as well.

Signature: _____ Date: _____
Request cannot be completed without signature.

NOTE: Please include a site plan with this request if for new service.

Email the completed request to UtilityApplication@csu.org or as an alternate, send completed request to appropriate Field Engineering Office (North Work Center handles gas).

North Work Center
7710 Durant Drive
P.O. Box 1103, Mail Code 2150
Colorado Springs, CO 80947-2150
Phone: (719) 668-4985
Fax: (719) 668-4998

South Work Center
1521 Hancock Expressway
P.O. Box 1103, Mail Code 1821
Colorado Springs, CO 80947-1821
Phone: (719) 668-5564
Fax: (719) 668-5956

For office use only

Work Order Number(s) _____

FE: _____ Phone: _____

**Colorado Springs Utilities
Non-Standard Gas Meter Loop Agreement**

The current Colorado Springs Utilities Gas “Line Extension & Service Standards“ Manual lists specifications for meter loops depending on total connected load. The specifications are for: 1) The horizontal distance from the Gas service riser to the building wall, 2) The horizontal distance from the gas service riser to the fuel gas piping inlet and 3) The vertical distance from the Gas service riser to the fuel gas piping inlet. The Manual also gives specifications for distances from doors and openings and other safety related items.

Colorado Springs Utilities expects all current Manual standards and specifications to be followed.

From time to time, and only due to unique circumstances, Colorado Springs Utilities may, in its sole discretion, make exceptions to the specifications so long as the exception does not jeopardize safety or in any way create a possible hazard.

Due to such circumstances on this particular job, Colorado Springs Utilities is granting an exception to our standard meter loop specification. Below you will find a detailed description of what the exception is. Only after the work is completed as described below and all applicable inspections have been completed by the Regional Building Department, will you be eligible to receive a gas meter.

Exception for:

Address: _____

Contractor: _____

Description of exception: _____

Drawing: _____

Contractor signature

Colorado Springs Utilities Rep

QC Inspection Sheet

QC Contact

WONUM
Description
Address
Contact
Company
Work Phone
Cell Phone
Work Type
Sub Work Type

Inspector	Date	FIELD NOTES
_____	__/__/__	Received From PA
		<u>WATER / WASTE WATER</u>
_____	__/__/__	Water Mains Installed
_____	__/__/__	Sewer Mains Installed
_____	__/__/__	Storm Sewer/ Drains Installed
_____	__/__/__	Water Services Installed
		<u>CURB AND GUTTER</u>
_____	__/__/__	Curb and Gutter Installed
_____	__/__/__	Curb Backfilled
		<u>LOT LOCATIONS</u>
_____	__/__/__	Front Lot Pins Installed
_____	__/__/__	Lot Lines Marked On Curb
_____	__/__/__	Flag Lot Pins Installed
_____	__/__/__	Rear Lot Pins Installed
		<u>CURB WAIVER INFO</u>
_____	__/__/__	Curb Waiver
_____	__/__/__	Grade Stakes @ 50 ft.
_____	__/__/__	Grade Within 6" Trench Line
_____	__/__/__	Grade Within 2" Equip Loc
		Joint Trench <input type="checkbox"/> YES <input type="checkbox"/> NO

RELEASED TO:

_____ Date __/__/__

North District Fax # 668-4998
 South District Fax # 668-5606
 Electric Service # 668-5535

I _____ UNDERSTAND ALL OBLIGATIONS I HAVE COMMITTED TO, WILL BE MET BEFORE ARRIVAL OF CSU CONSTRUCTION CREW. FAILURE, WILL RESULT IN THIS PROJECT GOING BACK ON THE 3 WEEK SCHEDULE.

Colorado Springs Utilities

Utility Staking Standards (New Residential and Commercial) Before Starting Job

When Colorado Springs Utilities’ facilities (Electric, Gas, Both – Joint Trench) are to be installed prior to the installation of curb and gutter, in private streets or right-of-way, that are designated as existing public utilities easements, the Developer or Developer’s Representative shall adhere to the following staking requirements:

- All wet utilities shall be installed prior to gas and electric installation – this includes storm water.
- Grade at Transformers, J-Boxes and Vaults to within +/- 3” of sub/final grade. On Streets, Easements and Right-Of-Ways to within +/- 6” of sub/final grade.
- Grade staking shall be provided at 25-foot spacing and located in the Right-Of-Way with offsets.
- Re-staking and/or additional staking, as needed, shall be provided within 48 hours of notice.
- Final grade staking shall have Station Numbers and Cut Sheets provided to a Colorado Springs Utilities Representative.
- Grade staking in Cul-De-Sac or Short Radius Turns, shall include Radius Points, Points of Curvature, Tangent Points, and be provided at a maximum of 15-foot spacing.
- Grade staking for Vaults, Transformer Pads, J-Boxes and Streetlights, shall have a minimum of two grade stakes, with no more than 5-foot offsets.
- Stakes shall be denoted in the format as follows: Station Number, Top Back Curb, Offset, Cut or Fill.
- The entire project shall have final staking before construction will commence, or as may otherwise be agreed upon with a Colorado Springs Utilities Quality Control Inspector or appropriate Colorado Springs Representative.
- Once construction has commenced, the Developer or Developer’s Representative shall work with the Colorado Springs Utilities Representative “on-site”, to provide adequate and appropriate staking, to eliminate any delays. Developer shall be responsible for delay costs due to inadequate staking.
- Verification survey shots shall be taken for Vaults, Transformer Pads and J-Boxes prior to the Construction Crew leaving the project, and Colorado Springs Utilities verification form shall be signed by the Developer or Developer’s Representative, indicating Colorado Springs Utilities’ release from the installed facilities.
- The Developer will incur all costs for improper installation or repositioning of facilities, due to staking errors or changes in grade. Once this verification form has been signed, the Developer will be responsible for corrections to utility facilities.
- The Developer understands that the staking provided may be destroyed upon installation of utilities.

WO#: _____
Job Address: _____
Project Name: _____
Developer /
Representative: _____

Colorado Springs Utilities Representative: _____

Signature _____ Date ____/____/____

Colorado Springs Utilities

Utility Staking Standards (Verification Form)

Date: _____/_____/_____

WO#: _____

Job Address/Project Name: _____

Developer: _____

Springs Utilities Representative _____

I, _____, as developer or developer's representative do hereby verify
(print name)

that the installation of the utilities on _____ are now completed
(project name)

as of the _____ day of _____, year _____ and are positioned per the staking that
(Date) (month) (year)

I have provided.

Signature: _____ **Date:** ____/____/____

Comments:

Orig.: PA/QC Copy: Dev.



Work Order #

Economically Feasible (and <\$100,000)

EXTENSION CONTRACT

THIS AGREEMENT (the "Contract"), made on the ____ day of _____, 20____, by and between the Colorado Springs Utilities, an enterprise of the City of Colorado Springs, a home rule city and Colorado municipal corporation ("Colorado Springs Utilities"), and _____, a _____, (the "Applicant").

RECITALS:

A. Applicant requests that natural gas facilities, which Colorado Springs Utilities will own, be constructed by Colorado Springs Utilities in order to supply gas service to _____; and

B. Colorado Springs Utilities is willing to construct requested facilities in accord with its lawful tariffs, rules, regulations and rates to maintain the safety and integrity of the existing system; and

C. In accord with Colorado Springs Utilities' Natural Gas Tariffs, extension costs include labor, materials equipment charges, overheads, permits and other out-of-pocket expenses for engineering, installing and connecting facilities to the distribution system. Applicant has submitted the following required Non-Refundable Fees:

1. Design Fee of \$ _____ (non-refundable); and
2. Commercial Inspection & Tie-in Fee \$ _____ (non-refundable); and
3. Total Cost of Extension \$ _____ multiplied by Thirty percent (30%) for a total Contribution-in Aid payment of \$ _____; and
4. Design Fee + Commercial Inspection & Tie-in Fee + Contribution-in-Aid payment = Total Non-Refundable Fee payment of \$ _____; and

The Total Non-Refundable Fee is required prior to the start of construction, which Utilities has determined to be economically feasible. The Total Non-Refundable Fee payment does not include any Applicant Requested Extras. Applicant has conveyed all necessary rights-of-way for constructed facilities to the appropriate entity in a form acceptable to Colorado Springs Utilities; and

D. Colorado Springs Utilities and Applicant desire that their agreement, relative to this natural gas facility extension, be in writing.

NOW, THEREFORE, in consideration of the mutual promises and covenants of the parties, **IT IS AGREED:**

CONDITIONS:

1. Based upon preliminary field survey, design and estimate, the Total Non-Refundable Fee for these natural gas facilities shall be paid to Colorado Springs Utilities by the Applicant.

2. Failure of the Applicant to advance the amount specified shall in no way obligate Colorado Springs Utilities to construct the requested facilities at its own expense.

3. Colorado Springs Utilities may refuse to make connections to the system constructed pursuant to this Contract until all amounts due Colorado Springs Utilities have been paid.

4. Applicant shall be solely responsible for all costs associated with unstable soil conditions in new streets or easements constructed by the Applicant, or other unexpected costs. Such costs shall include, but not be limited to, damages to gas facilities and associated gas line trenches caused by poor soil composition, inadequate drainage (from either surface or subsurface water), extreme weather conditions or extended exposure of gas line trenches to environmental elements and vehicle loading. Applicant further agrees to notify Colorado Springs Utilities of any unstable soil conditions affecting gas trenches or facilities, and to perform mitigation efforts, at its sole expense, to repair unstable gas line trenches to Colorado Springs Utilities' specifications and in the presence of a Colorado Springs Utilities Construction Inspector.

5. In the event the Applicant wishes to have Colorado Springs Utilities or its Contractor perform the required work resulting from conditions described in Paragraph No. 6 below, Colorado Springs Utilities shall require the applicant to execute a Time and Materials Contract. All costs shall be paid to Colorado Springs Utilities according to the terms of the Time and Materials Contract, and shall not be eligible for refund under any Refund Contract with Colorado Springs Utilities.

6. Under extenuating circumstances such that Colorado Springs Utilities approves the installation of gas facilities prior to the installation of curb and gutter, or in streets or easements where curb and gutter will not exist, Applicant shall assure that such streets or easements are constructed to within six inches (6") of sub-grade and in a reasonable condition prior to the installation of gas facilities. Applicant shall provide staking in the form of curb and gutter staking, property line grade staking or off-set grade staking. Staking shall include cut and fill dimensions and Applicant shall provide cut and fill sheets as requested. Applicant shall be solely responsible for all costs associated with staking. Applicant shall be liable for the cost of any relocation or adjustment of gas facilities necessitated by a change in alignment or grade from that staked.

7. Applicant shall be responsible, at its sole expense, for locating any private underground facilities including empty conduits and sprinkler systems. Applicant shall

be solely responsible for all costs associated with damages to private facilities that are not located at the time of construction.

8. Any taps requested by the Applicant or others, to these facilities, shall be subject to the approval of Colorado Springs Utilities and to the availability of natural gas at the time of the request.

9. This Contract may be assigned by the Applicant provided that the assignment is in writing, that the execution of the assignment by Applicant or Applicant's duly appointed representative is properly notarized and that the written approval of Colorado Springs Utilities is obtained prior to the assignment becoming effective. For purposes of approving any such assignment, Colorado Springs Utilities may rely on the notarized signatures without further investigation. If an assignment meets the requirements of this paragraph and is approved by Colorado Springs Utilities, the terms, covenants, conditions, provisions, and agreements of this Contract shall then become binding upon the Applicant and the assignee(s) as provided in the assignment. The Applicant and assignee(s) also agree to indemnify, defend, save and hold harmless Colorado Springs Utilities from any expense, claim or loss incurred by Colorado Springs Utilities as a result of performing its obligations under this Contract, including payment of refunds. So long as any payments due under this Contract are made in accord with the Contract or any assignment approved by Colorado Springs Utilities, Colorado Springs Utilities shall have no liability to Applicant, any assignee(s) or third parties on account of such payments.

10. The Applicant shall notify Colorado Springs Utilities in writing of any change of address, and waives any cause of action resulting from failure to notify Colorado Springs Utilities of any change of address.



Colorado Springs Utilities
It's how we're all connected

By _____
Title **Field Engineering Supervisor**
System Extensions
Planning and Engineering
Date _____ (date signed)

This contract is in accord with the contract form approved by the City Attorney's Office – Utilities Division.

(Applicant)

By

By _____

(print name)

Title _____

Date _____

(date Applicant signed)

Address _____

Phone _____



Work Order #

EXTENSION CONTRACT

THIS AGREEMENT (the “Contract”), made on the ____ day of _____, **20**____, by and between the Colorado Springs Utilities, an enterprise of the City of Colorado Springs, a home rule city and Colorado municipal corporation (“Colorado Springs Utilities”), and _____, a _____ (the “Applicant”).

RECITALS:

A. Applicant requests that natural gas facilities, which Colorado Springs Utilities will own, be constructed by Colorado Springs Utilities in order to supply gas service to _____; and

B. Colorado Springs Utilities is willing to construct requested facilities in accord with its lawful tariffs, rules, regulations and rates; and

C. In accord with Colorado Springs Utilities' Natural Gas Tariffs, Applicant has submitted the following required fees:

1. Design Fee of \$ _____ (non-refundable); and
2. Commercial Inspection & Tie-in Fee \$ _____ (non-refundable); and
3. Construction Cost of Extension (refundable) \$ _____ ; and
4. Design Fee + Commercial Inspection & Tie-in Fee + Construction Cost =Total Fee payment of \$ _____; and

Applicant has advanced the Total Fee payment and has conveyed all necessary rights-of-way for constructed facilities to the appropriate entity in a form acceptable to Colorado Springs Utilities; The Total Fee payment does not include any Applicant Requested Extras; and

D. Colorado Springs Utilities and Applicant desire that their agreement, relative to this natural gas facility extension, be in writing.

NOW, THEREFORE, in consideration of the mutual promises and covenants of the parties, **IT IS AGREED:**

CONDITIONS:

1. Based upon preliminary field survey, design and estimate, the Total (a portion is refundable – only the design fee is non-refundable) Fee for these natural gas facilities shall be paid to Colorado Springs Utilities by the Applicant.

2. Failure of the Applicant to advance the amount specified shall in no way obligate Colorado Springs Utilities to construct the requested facilities at its own expense.

3. If the actual costs of construction exceed the sum of amount advanced by the Applicant, the Applicant shall pay the balance to Colorado Springs Utilities no later than 60 days after notification. After all amounts due to Colorado Springs Utilities have been paid, the Applicant will be entitled to execute a Refund Contract as provided for in the Natural Gas Tariffs, as may be subsequently modified, as set forth by the City Council and on file in the City's Clerk's Office.

4. If the actual costs of construction are less than the sum of money advanced by the Applicant, Colorado Springs Utilities shall refund, without interest to the Applicant, the difference between the estimated and actual costs of construction.

5. Colorado Springs Utilities may refuse to make connections to the system constructed pursuant to this Contract until all amounts due Colorado Springs Utilities have been paid.

6. Applicant shall be solely responsible for all costs associated with unstable soil conditions in new streets or easements constructed by the Applicant, or other unexpected costs. Such costs shall include, but not be limited to, damages to gas facilities and associated gas line trenches caused by poor soil composition, inadequate drainage (from either surface or subsurface water), extreme weather conditions or extended exposure of gas line trenches to environmental elements and vehicle loading. Applicant further agrees to notify Colorado Springs Utilities of any unstable soil conditions affecting gas trenches or facilities, and to perform mitigation efforts, at its sole expense, to repair unstable gas line trenches to Colorado Springs Utilities' specifications and in the presence of a Colorado Springs Utilities Gas Pipeline Inspector.

7. In the event the Applicant wishes to have Colorado Springs Utilities or its Contractor perform the required work resulting from conditions described in Paragraph No. 6 herein, Colorado Springs Utilities shall require the applicant to execute a Time and Materials Contract. All costs shall be paid to Colorado Springs Utilities according to the terms of the Time and Materials Contract, and shall not be eligible for refund under any Refund Contract with Colorado Springs Utilities.

8. Under extenuating circumstances such that Colorado Springs Utilities approves the installation of gas facilities prior to the installation of curb and gutter, or in streets or easements where curb and gutter will not exist, Applicant shall assure that such streets or easements are constructed to within six inches (6") of sub-grade and in a reasonable condition prior to the installation of gas facilities. Applicant shall provide staking in the form of curb and gutter staking, property line grade staking or off-set grade staking. Staking shall include cut and fill dimensions and Applicant shall provide cut and fill sheets as requested. Applicant shall be solely responsible for all costs associated with staking. Applicant shall be liable for the cost of any relocation or adjustment of gas facilities necessitated by a change in alignment or grade from that staked.

9. Applicant shall be responsible, at its sole expense, for locating any private underground facilities including empty conduits and sprinkler systems. Applicant shall

be solely responsible for all costs associated with damages to private facilities that are not located at the time of construction.

10. Any taps requested by the Applicant or others, to these facilities, shall be subject to the approval of Colorado Springs Utilities and to the availability of natural gas at the time of the request.

11. This Contract may be assigned by the Applicant provided that the assignment is in writing, that the execution of the assignment by Applicant or Applicant's duly appointed representative is properly notarized and that the written approval of Colorado Springs Utilities is obtained prior to the assignment becoming effective. For purposes of approving any such assignment, Colorado Springs Utilities may rely on the notarized signatures without further investigation. If an assignment meets the requirements of this paragraph and is approved by Colorado Springs Utilities, the terms, covenants, conditions, provisions, and agreements of this Contract shall then become binding upon the Applicant and the assignee(s) as provided in the assignment. No refunds shall be paid to any assignee(s) of the Contract until the assignment is approved by Colorado Springs Utilities, and the Applicant and any assignee(s) waive any right of action resulting from the failure of the Applicant and/or assignee(s) to comply with the requirements set forth in this paragraph. The Applicant and assignee(s) also agree to indemnify, defend, save and hold harmless Colorado Springs Utilities from any expense, claim or loss incurred by Colorado Springs Utilities as a result of performing its obligations under this Contract, including payment of refunds. So long as any payments due under this Contract are made in accord with this Contract or any assignment approved by Colorado Springs Utilities, Colorado Springs Utilities shall have no liability to Applicant, any assignee(s) or any third parties on account of such payments.

12. This Contract is subject to rights of setoff; Colorado Springs Utilities may set off, against any refund owed to Applicant, any amounts that Applicant owes to Colorado Springs Utilities. In the event Colorado Springs Utilities exercises its right of setoff, it shall provide an accounting to Applicant to the extent of the amount set off in lieu of the refund payment of such amount.

13. The Applicant shall notify Colorado Springs Utilities in writing of any change of address, and waives any cause of action resulting from failure to notify Colorado Springs Utilities of any change of address. The Applicant hereby agrees to indemnify, defend, save and hold harmless Colorado Springs Utilities against any expense or loss incurred by Colorado Springs Utilities attempting to deliver refunds due to the failure of the Applicant to provide the said notification, or as a result of Colorado Springs Utilities effort to enforce and comply with this Contract, or as a result of a claim by a third party for damages or for the right to a refund under this Contract.

14. This Contract shall terminate upon execution of a Refund Contract between Colorado Springs Utilities and the Applicant.



Colorado Springs Utilities
It's how we're all connected

By _____
Title **Field Engineering Supervisor**
System Extensions
Planning and Engineering

Date _____ (date signed)
This contract is in accord with the contract form
approved by the Utilities General Counsel Division
on 00/00/04

(Applicant)

By
By _____

(print name)

Title _____

Date _____
(date Applicant signed)

Address _____

Phone _____

Sample



**COLORADO SPRINGS UTILITIES
 CUSTOMER CONTRACT ADMINISTRATION
 2880 International Cir, Suite 210 • Colorado Springs, CO 80910
 Phone (719) 668-8111 Fax (719) 668-8130
SINGLE PARCEL REFUND CONTRACT**

THIS AGREEMENT (the “Contract”), which becomes effective on the ____ day of _____, _____, the date the gas facilities covered by this Contract were charged with natural gas, by and between the Colorado Springs Utilities, an enterprise of the City of Colorado Springs, a home-rule city and Colorado municipal corporation, with its principal place of business at 121 S Tejon Street, Colorado Springs, Colorado 80903, (hereinafter referred to as Colorado Springs Utilities), and _____, a (*Corporation, Natural Person, Special District, Govt Entity, etc.*), hereinafter referred to as Applicant, for (*Project Name*), WO# _____.

RECITALS

A. Applicant has requested that natural gas facilities be constructed by Colorado Springs Utilities in order to supply gas service as shown on the attached map(s); and

B. Colorado Springs Utilities has constructed requested gas facilities in accordance with its lawful tariffs, rules, regulations and rates (collectively, the Tariffs) under the Extension Contract dated _____, which shall be superseded by this Contract; and

C. Applicant has advanced the sum of \$(*As-Built Cost*) to Colorado Springs Utilities (the “Deposit”) to reimburse Colorado Springs Utilities for the Applicant’s portion of the actual construction costs, and has conveyed all necessary rights-of-way for constructed facilities to the appropriate entity in a form acceptable to Colorado Springs Utilities; and

D. Colorado Springs Utilities and Applicant desire that their agreement concerning this gas facility extension be in writing.

NOW, THEREFORE, in consideration of the premises and mutual promises of the parties as hereinafter set forth, IT IS AGREED;

CONDITIONS

1. For a period of ten years from the date of this Contract, Colorado Springs Utilities shall make a refund to the Applicant for each new gas connection made to the gas facilities described in this Contract. Refunds shall be calculated as specified in the Tariffs in effect at the time of connection, as set forth by the City Council and on file in the Office of the City Clerk/Treasurer. Refunds shall be paid to the Applicant on a periodic basis, without interest.

2. Any connections requested by the Applicant or others, to these facilities, shall be subject to the approval of Colorado Springs Utilities and to the availability of gas at the time of request.

3. Applicant acknowledges that, depending upon the number and size of the connections, the amounts refunded may be less than the Applicant's Deposit with Colorado Springs Utilities. Applicant further understands that in no event will the total amounts refunded under this Contract exceed the Deposit, nor will any refunds be made after expiration of this Contract’s term. Any unrefunded portion of the Deposit which exists at Contract expiration will become a contribution-in-aid of construction to Colorado Springs Utilities, as provided in the Tariffs.

4. Applicant understands that additional gas service connections will be provided only if gas is available when requested and in conformance with Colorado Springs Utilities Tariffs in effect at the time such additional gas service connections are requested by the Applicant or others desiring to obtain service from this extension.

5. Under the terms of this Contract, additional gas service connections installed after the completion of an extension may be eligible for refunds. Refunds for such service connections shall be provided in accordance with the provisions specified in the Tariffs, and such refunds shall be reduced by the actual cost of installing the additional new service stubs required to make the connection.

6. This Contract may be amended for the purpose of accommodating changes as a result of subdivision re-plats requiring the removal or abandonment of service stubs or the abandonment of gas mains. In the event that such changes to the gas system are requested by the Applicant, Colorado Springs Utilities and Applicant may execute an amendment to this Contract as a condition of approval of the gas system change. The amendment will reduce the remaining Deposit by the actual value of the abandoned or removed facilities which were originally installed under this Contract. Colorado Springs Utilities shall be compensated for such changes according to its Time and Materials Work Request procedures in effect at the time of the request. A contract amendment may not be used to alter the duration of the Contract unless permitted under the Tariffs.

7. This Contract may be assigned by the Applicant provided that the assignment is in writing, that the execution of the assignment by Applicant or Applicant's duly appointed representative is properly notarized, and that the written approval of Colorado Springs Utilities is obtained prior to the assignment becoming effective. For purposes of approving any such assignment, Colorado Springs Utilities may rely on the notarized signatures without further investigation. If an assignment meets the requirements of this paragraph and is approved by Colorado Springs Utilities, the terms, covenants, conditions, provisions, and agreements of this Contract shall thereafter become binding upon the Applicant and the assignee(s) as provided in the assignment. No refunds shall be paid to any assignee(s) of the Contract until the assignment is approved by Colorado Springs Utilities, and the Applicant and any assignee(s) waive any right of action resulting from the failure of the Applicant and/or assignee(s) to comply with the requirements set forth in this paragraph. The Applicant and assignee(s) also agree to indemnify, defend, save and hold harmless Colorado Springs Utilities from any expense, claim or loss incurred by Colorado Springs Utilities as a result of performing its obligations under this Contract, including payment of refunds. So long as any payments due under this Contract are made in accordance with this Contract or any assignment approved by Colorado Springs Utilities, Colorado Springs Utilities shall have no liability to Applicant, any assignee(s) or any third parties on account of such payments.

8. This Contract is subject to rights of setoff; Colorado Springs Utilities may set off, against any refund owed to Applicant, any amounts that Applicant owes to Colorado Springs Utilities. In the event Colorado Springs Utilities exercises its right of setoff, it shall provide an accounting to Applicant to the extent of the amount set off in lieu of the refund payment of such amount.

9. The Applicant shall notify Colorado Springs Utilities in writing of any change of address, and waives any right of action resulting from failure to notify Colorado Springs Utilities of any change of address. The Applicant hereby agrees to indemnify, defend, save and hold harmless Colorado Springs Utilities against any expense or loss incurred by Colorado Springs Utilities attempting to deliver refunds due to the failure of the Applicant to provide the said notification, or as a result of Colorado Springs Utilities effort to enforce and comply with this Contract, or as a result of a claim by a third party for damages or a refund under this Contract.

COLORADO SPRINGS UTILITIES

CUSTOMER

Authorized Signature

Authorized Signature

Printed Name

Printed Name

Supervisor, Customer Contract Administration
Title

Title

Date

Date

Approved as to form by the City Attorney's Office-Utilities Division:

Sample



**COLORADO SPRINGS UTILITIES
CUSTOMER CONTRACT ADMINISTRATION**
2880 International Cir, Suite 210 • Colorado Springs, CO 80910
Phone (719) 668-8111 Fax (719) 668-8130
MAINLINE FACILITIES REFUND CONTRACT

THIS AGREEMENT (the “Contract”), which becomes effective on the ____ day of _____, _____, the date the gas facilities covered by this Contract were charged with natural gas, by and between the Colorado Springs Utilities, an enterprise of the City of Colorado Springs, a home-rule city and Colorado municipal corporation, with its principal place of business at 121 S Tejon Street, Colorado Springs, Colorado 80903, (hereinafter referred to as Colorado Springs Utilities), and _____, a (*Corporation, Natural Person, Special District, Govt Entity, etc.*), hereinafter referred to as Applicant, for (*Project Name*), WO# _____.

RECITALS

A. Applicant has requested that natural gas mainline facilities be constructed by Colorado Springs Utilities in order to supply gas service as shown on the attached map(s); and

B. Colorado Springs Utilities has constructed requested gas facilities in accordance with its lawful tariffs, rules, regulations and rates (collectively, the “Tariffs”) under the Extension Contract dated _____, _____. Said Extension Contract shall be superseded by this Contract; and

C. Applicant has advanced the sum of \$(*As-Built Cost*) to Colorado Springs Utilities (the “Deposit”) to reimburse Colorado Springs Utilities for the Applicant’s portion of the actual construction costs, and has conveyed all necessary rights-of-way for constructed facilities to the appropriate entity in a form acceptable to Colorado Springs Utilities; and

D. Colorado Springs Utilities and Applicant desire that their agreement relative to this gas facility extension be in writing.

NOW, THEREFORE, in consideration of the premises and mutual promises of the parties as hereinafter set forth, IT IS AGREED:

CONDITIONS

1. For a period of twenty years from the date of this Contract, Colorado Springs Utilities shall make refunds to the Applicant based upon the ratio of actual connected load to expected load. The expected load to be served by the facilities described in this Contract is __MCFH. Refunds shall be calculated as specified in the Tariffs in effect at the time of connection, as set forth by the City Council and on file in the City’s Clerk/Treasurer. Refunds shall be paid to the Applicant on an annual basis, without interest.

2. Any connections to this main extension requested by the Applicant or others shall be subject to the approval of Colorado Springs Utilities and to the availability of gas at the time of request.

3. Applicant acknowledges that, depending upon the build-out rate and the load connections to the system, the amounts refunded may be less than the Applicant’s Deposit with Colorado Springs Utilities. Applicant further understands that in no event will the total amounts refunded under this Contract exceed the Deposit, nor will any refunds be made after expiration of this Contract’s term. Any unrefunded portion of the Deposit which exists at Contract expiration will become a contribution-in-aid of construction to Colorado Springs Utilities, as provided in the Tariffs.

4. Applicant understands that additional gas service connections will be provided only if gas is available when requested and in conformance with Colorado Springs Utilities Tariffs at the time such additional gas is requested by the Applicant or others desiring to obtain service from these extensions.

5. This Contract may be amended for the purpose of accommodating changes as a result of subdivision re-plats requiring the removal or abandonment of service stubs or the abandonment of gas mains. In the event that such changes to the gas system are requested by the Applicant, Colorado Springs Utilities and Applicant may execute an amendment to this Contract as a condition of approval of the gas system change. The amendment will reduce the remaining Deposit by the actual value of the abandoned or removed facilities which were originally installed under this Contract. Colorado Springs Utilities shall be compensated for such changes according to its Time and Materials Work Request procedures in effect at the time of the request. A contract amendment may not be used to alter the duration of the Contract unless permitted under Tariffs.

6. This Contract may be assigned by the Applicant provided that the assignment is in writing, that the execution of the assignment by Applicant or Applicant's duly appointed representative is properly notarized, and that the written approval of Colorado Springs Utilities is obtained prior to the assignment becoming effective. For purposes of approving any such assignment, Colorado Springs Utilities may rely on the notarized signatures without further investigation. If an assignment meets the requirements of this paragraph and is approved by Colorado Springs Utilities, the terms, covenants, conditions, provisions, and agreements of this Contract shall thereafter become binding upon the Applicant and the assignee(s) as provided in the assignment. No refunds shall be paid to any assignee(s) of the Contract until the assignment is approved by Colorado Springs Utilities, and the Applicant and any assignee(s) waive any right of action resulting from the failure of the Applicant and/or assignee(s) to comply with the requirements set forth in this paragraph. The Applicant and assignee(s) also agree to indemnify, defend, save and hold harmless Colorado Springs Utilities from any expense, claim or loss incurred by Colorado Springs Utilities as a result of performing its obligations under this Contract, including payment of refunds. So long as any payments due under this Contract are made in accordance with this Contract or any assignment approved by Colorado Springs Utilities, Colorado Springs Utilities shall have no liability to Applicant, any assignee(s) or any third parties on account of such payments.

7. This Contract is subject to rights of setoff; Colorado Springs Utilities may set off, against any refund owed to Applicant, any amounts that Applicant owes to Colorado Springs Utilities. In the event Colorado Springs Utilities exercises its right of setoff, it shall provide an accounting to Applicant to the extent of the amount set off in lieu of the refund payment of such amount.

8. The Applicant shall notify Colorado Springs Utilities in writing of any change of address, and waives any right of action resulting from failure to notify Colorado Springs Utilities of any change of address. The Applicant hereby agrees to indemnify, defend, save and hold harmless Colorado Springs Utilities against any expense or loss incurred by Colorado Springs Utilities attempting to deliver refunds due to the failure of the Applicant to provide the said notification, or as a result of Colorado Springs Utilities effort to enforce and comply with this Contract, or as a result of a claim by a third party for damages or a refund under this Contract.

COLORADO SPRINGS UTILITIES

CUSTOMER

Authorized Signature

Authorized Signature

Printed Name

Printed Name

Supervisor, Customer Contract Administration
Title

Title

Date

Date

Approved as to form by the City Attorney's Office-Utilities Division:

Sample

**REQUEST FORM FOR COLORADO SPRINGS UTILITIES TO WORK
OVERTIME**

Date _____

Re: T&M Overtime Request

Colorado Springs Utilities

Field Engineering- North Work Center
7710 Durant Drive
Colorado Springs, CO 80920

Field Engineering- South Work Center
1521 Hancock Expressway
Colorado Springs, CO 80903

Dear Colorado Springs Utilities:

This is a request for the Gas & Electric Extension Crews (Colorado Springs Utilities or Contractor) to work overtime on _____ Subdivision (project name and filing number). Overtime will only be worked as resources are available. The overtime worked will help expedite the process of the installation of the gas and electric extension, which is needed at this time. It is understood that any money paid for overtime work is not part of the base contract and is non-refundable.

Thank you for your assistance in this matter. If you have any questions, please contact me at _____.

Sincerely,

_____ (print name)

_____ (title)

_____ (company name)

_____ (billing address)

_____ (requested number of overtime hours)

_____ (date(s) for requested overtime)

Frost Approval Form (New Residential and Commercial)
Before Starting the Job

When Colorado Springs Utilities' facilities (Gas and Joint Trench) are to be installed during frost conditions, the following processes will be applied.

Gas Only Project:

If frost conditions are encountered during installation, Colorado Springs Utilities will dig the first top 6” of frost at no additional cost. Any additional 6” increments of frost will require additional monies to complete the project. Monies paid per the Tariff to dig in frost will not be refunded as part of any single parcel or mainline contract. Utilities crews must complete the “Payment Itemization” sheet and Utilities’ contractors should use the appropriate frost bid units for digging in frost. Field Engineering will reconcile the costs after the project construction is completed.

If the Contractor is already on site, a T&M work order will be created to charge any down time to while Developer’s representative excavates the ditches. If the developer chooses not to pay for Colorado Springs Utilities/Contractor excavating in frost and the Contractor must return later, the Developer will incur a remobilization fee.

Gas & Electric Joint Trench Project:

Electric - Installation of the primary conduit and conductors, transformer pads, vaults, and service conductor will be installed by Colorado Springs Utilities. At the discretion of Colorado Springs Utilities, the customer may be required to furnish all necessary trenches, excavations to meet standards set forth by Colorado Springs Utilities. A credit will be given based on average trenching costs to Colorado Springs Utilities in average soils. Colorado Springs Utilities will, in these cases, select the backfill to cover all conductors. If the excavated material contains rock, it will not be satisfactory for backfill and the customer will be required to supply proper fill material and compaction. Any alterations or relocation of the underground electrical lines as installed in said subdivision will be done at the customer’s expense. While anyone else digging the ditches is strongly discouraged, and excavations shall meet Colorado Springs Utilities/Contractor standards and all safety requirements.

Gas – If the customer requests Colorado Springs Utilities to excavate the joint trench ditch in frost, customer will be responsible for 50% of the additional monies to complete the project. The remaining additional cost will be charged to electric and absorbed by Colorado Springs Utilities per the Tariff.

By signing this document, the Developer/Representative approves COLORADO SPRINGS UTILITIES and/or their designated contractor to install infrastructure if frost is encountered within the project and agrees to pay the additional cost upon reconciliation.

WO#: _____
Job Address: _____
Project Name: _____
Developer/Representative: _____

Colorado Springs Utilities Representative: _____ **Date:** _____

Developer/Representative: _____ **Date:** _____

TABLE OF CONTENTS

CHAPTER 3 Utility Service Installer License Rules and Procedures

Paragraph Number	Title	Page Number
3.01	Introduction.....	3-2
3.02	Utility Service Installer Licensing Program	3-2
3.02 a)	Utility Service Installer License Process	3-2
3.02 b)	Certificate of Insurance	3-4
3.02 c)	Drug and Alcohol Program.....	3-4
3.02 d)	Service Installer License Renewal, Suspension and Revocation Process.	3-5
3.02 e)	Fees	3-7
3.02 f)	Records Management.....	3-7

CHAPTER 3

Utility Service Installer License Rules and Procedures

3.01 Introduction

These Utility Service Installer license rules and procedures and the related licensing program are promulgated by the Chief Executive Officer of Utilities in accordance with Chapter 12, Article 3, Sections 12.3.303 through 12.3.313 of the Code of the City of Colorado Springs. Colorado Springs Utilities' employees and their contractors will follow internal processes to ensure compliance for service installation. Per City Code, a Utility Service Installer (LUSI) is any natural person licensed by Colorado Springs Utilities to install natural gas service lines.

3.02 Utility Service Installer Licensing Program:

a) Utility Service Installer License Process:

- 1) A Utility Service Installer license can be obtained after meeting the requirements listed below.
 - a) Providing evidence that the LUSI is enrolled in Utilities' drug and alcohol testing compliance monitoring program through DISA Compliance Monitoring (DCM Reporting) and has been issued a satisfactory rating.
 - b) Providing a current Certificate of Insurance (meeting the Building Contractor "A" requirements of the Pikes Peak Regional Building Code, RBC201.7.1).
 - c) Attending a Knowledge, Skill and Licensing assessment class; (Optional)
 - d) Passing a written licensing examination; (upon passing, proceed to step #e)
 - e) Attending an Operator Qualified (OQ) task training class; (Optional)
 - f) Passing a written OQ examination; (upon passing, proceed to step #g)
 - g) Passing a practical hands-on OQ task evaluation on the tasks determined by Utilities to be required for gas service installations.
- 2) Utility Service Installer Knowledge, Skill and Licensing and OQ assessments (written exams) will be scheduled and held each calendar year. Such written exams will be scheduled throughout the year but typically in the months of January, April, July and October. To sign up for one of these scheduled assessments (or optional training), contact 719-668- 2TIE. It is the responsibility of the LUSI to monitor their license and OQ expiration dates and to sign up for and attend the scheduled assessments prior to the expiration date printed on their license. A current Certificate of Insurance, and evidence that the LUSI participates in Utilities' drug and alcohol testing compliance monitoring program with a satisfactory rating through DCM reporting, must be provided to the Utility Construction and Maintenance Department prior to being eligible to take an assessment and/or OQ exam.-

- 3) The written licensing examination for the Utility Service Installer Knowledge, Skill and Licensing will cover Chapter 4 of the Gas Line Extension & Service Standards (Service Line Design and Construction). The minimum passing score on each part of the written examination is 80 percent. An applicant who fails to achieve a passing score on the written licensing examination will be required to retake the exam the following quarter or next available class. When a passing score has been achieved on the written licensing examination, the applicant may proceed to the OQ portion of the training and assessment.
- 4) Following a passing score for the Utility Service Installer Knowledge, Skill and Licensing written examination (discussed above), the applicant proceeds to the OQ written examination. The written examination for OQ will cover topics in the OQ lesson plan. The plan is provided when the appointment is made. Optional classroom training is provided quarterly by Utilities before the OQ knowledge assessment (call 719-668-2TIE to sign up for training). The minimum passing score for the written OQ examination is 80 percent. If the applicant fails the OQ written examination, they must wait 24 hours prior to retaking the test. Scheduling of testing is subject to availability of Colorado Springs Utilities OQ training staff.
- 5) When a passing score has been achieved on the written examination for OQ, the applicant may proceed to the hands-on OQ task performance evaluation (TPE) portion of the training and assessment. Colorado Springs Utilities provides maintained and calibrated tools for hands-on testing (Colorado Springs Utilities staff or contractor staff periodically inspect the LUSIs' tools in the field to verify that they have been properly maintained). An applicant in the initial hands on testing session has a maximum of three attempts to pass the evaluation (three attempts at the same day appointment). An applicant who fails the initial hands-on task evaluation must wait a minimum of 24 hours prior to retaking the hands-on test and attending a second testing session. Only one attempt is allowed during the second testing session. Re-test scheduling is subject to availability of Colorado Springs Utilities OQ training staff. An applicant that fails the OQ written or hands-on test after two testing sessions (regardless of size of fitting tested on) must have approval from the Gas Construction Quality Control Inspector Supervisor in order to test again (third test session) on any or all parts of the licensing process. Approval to take the test a third time will be based upon various factors, such as the applicant's understanding, knowledge, and performance in previous testing. Denial of or failure on a third attempt shall deem the applicant no longer eligible to be qualified for a period of two years. Utilities determines the specific OQ tasks required for licensing and gas service installations.
- 6) As one of the OQ task evaluations, applicants will be required to demonstrate the ability to make socket heat fusions on all polyethylene pipe sizes for which they desire to be licensed. LUSIs are only licensed to perform fusions on sizes that they were tested on and passed the hands on OQ task evaluation. Opportunity to add additional fusion sizes to their license will be provided throughout the year and subject to OQ training staff availability. Typically, LUSIs will not be able to add another fusion size to their license until the following quarterly class.
- 7) All portions of the OQ training and assessment will comply with provisions of 49 Code of Federal Regulations (CFR) Part 192, Subpart N (Qualification of Pipeline Personnel).
- 8) Once licensed, the LUSI shall keep their employment information current with

Colorado Springs Utilities, Utility Construction and Maintenance Department (719-668-3524, option 2).

- 9) A Utility Service Installer license will be issued upon successful completion of the items listed above in 3.02 a)1). The Utility Service Installer must present the license at the request of any employee of Colorado Springs Utilities, Utility Construction and Maintenance Department or Colorado Public Utilities Commission (PUC). Failure to present the license will result in the rejection of service line(s), as well as possible suspension or revocation of the license.

b) Certificate of Insurance:

A current Certificate of Insurance provided by the Contractor or by the LUSI must be on file with the Colorado Springs Utilities, Utility Construction and Maintenance Department before the Contractor or LUSI may install natural gas service lines. The types of insurance and amount of coverage required are the same as for Building Contractor “A”, licensed according to the Pikes Peak Regional Building Code, RBC201.7.1. Per Pikes Peak Regional Building Department (PPRBD), the Certificate of Insurance must also include the 10-day Cancellation/Reduction Clause. The Colorado Springs Utilities, Utility Construction and Maintenance Department shall be designated as an insurance certificate holder by the Contractor, LUSI or their insurance company. A Certificate of Insurance must be remitted upon renewal of the insurance policy or renewal of the Mechanical Contractor “A” license. If insurance is lapsed, cancelled or reduced, installation of natural gas service lines will not be permitted; and, in addition, lapse, cancellation or reduction of insurance below required amounts shall automatically suspend the LUSI until the required coverage is demonstrated to be reinstated.

c) Drug and Alcohol Program:

- 1) The LUSI or their employer must be registered with DCM Reporting to monitor their drug and alcohol testing program for compliance with 49 CFR Parts 40 and 199, must submit all required documentation to demonstrate compliance, and must maintain a satisfactory rating at all times.
- 2) In the event that a LUSI experiences a positive, refusal, or non-negative drug or alcohol test (as defined by 49 CFR Parts 40 and 199), the LUSI shall immediately notify the Colorado Springs Utilities Utility Construction and Maintenance Department.
- 3) Within 10 days of request by Utilities, the LUSI shall submit any documents requested pertaining to compliance with 49 CFR Parts 40 and 199, including but not limited to a policy and program plan and information regarding testing.
- 4) In the event it is determined that the drug and alcohol program in which one or more LUSI is enrolled is not a Compliant Drug and Alcohol Program, then the program shall be immediately modified to meet compliance requirements. Noncompliance, or failure to achieve and maintain a satisfactory rating through DCM Reporting, will result in suspension or revocation of all LUSIs subject to such program. The LUSI shall be liable for damages that Colorado Springs Utilities incurs based on any such noncompliance with 3.02 c).
- 5)

The LUSI, as a condition of licensure, must grant Utilities, DCM Reporting, the Colorado PUC, the U.S. Department of Transportation (DOT), and the federal Pipeline and Hazardous Materials Safety Administration (PHMSA) authority and access to audit its drug and alcohol program to ensure compliance with 49 CFR Parts 40 and 199, including but not limited to authority to inspect records maintained by any

Third-Party Administrator or Service Agent retained for such purposes.

d) Utility Service Installer License Renewal, Suspension and Revocation Process:

- 1) Each license shall be issued for a term of 3 years. **Prior to** the expiration of the term and upon application for renewal of the license, the LUSI must pass written examinations for both the licensing assessment and OQ knowledge assessment; and successfully complete the hands-on OQ task evaluations, to include a practical hands-on socket heat fusion for each size that they wish to be qualified.

The LUSI license will be automatically suspended if 1) a 12 month period has elapsed since the last fusion inspection by the Utility Construction and Maintenance Department, or 2) if the LUSI does not complete for license renewal the items in paragraph 3.02 a) within 3 years of the issue date of the license (the license has expired). The license is suspended until a re-instatement procedure is successfully completed. A LUSI who fails to demonstrate the ability to make socket heat fusions on all polyethylene pipe sizes for which they desire to be licensed will be required to retake the hands on OQ task evaluation the following quarter.

- 2) Grounds for Suspension of a Utility Service Installer License. A Utility Service Installer license may be suspended by the Colorado Springs Utilities, Utility Construction and Maintenance Department Manager for any of the following, referenced herein as “Violations”:
 - a) Violation of any provision of the Code of the City of Colorado Springs pertaining to the license, or of any regulation or order relating to the license lawfully made under the authority of that Code.
 - b) Violation of any provision of these Utility Service Installer License Rules and Procedures, Colorado Springs Utilities’ Tariffs or Colorado Springs Utilities’ Line Extension and Service Standards, including OQ procedures.
 - c) Violation of any law of the United States, of the State of Colorado or of the City of Colorado Springs when the violation concerns conduct or activity related to the installation and safety of natural gas service lines.
 - d) Failure to maintain a Compliant Drug and Alcohol Program or otherwise failure to comply with the terms of 3.02 c).
 - e) The licensee’s conduct, or that of any agent or employee of the licensee, rises to the level of a threat to the health, safety or welfare of the public or Utilities personnel.
 - f) A natural gas service line installation performed by the LUSI is deemed unsafe or hazardous in the sole discretion of the Utility Construction and Maintenance Department Manager.

- 3) When a LUSI commits a Violation, the Utility Construction and Maintenance Department Manager may immediately suspend the LUSI or, alternatively, recommend that the LUSI be suspended upon a stated future date, but in either case the suspension shall be for a minimum period of 30 days and until all requirements for re-instatement are met. Utilities will notify the LUSI of any immediate suspension or the suspension recommendation, including the date and time at which the suspension decision or recommendation will be heard by the General Manager of the Utility Construction and Maintenance Department or their designee. The LUSI may appear and present evidence as to why the suspension should not occur. The decision of the General Manager of the Utility Construction and Maintenance Department shall be final regarding the suspension. Prior to re-instatement of the LUSI after a suspension, the licensee must complete a re-instatement procedure. The re-instatement procedure following a suspension includes review of and compliance with all required components of the initial Utility Service Installer license procedure as listed in paragraph 3.02 a) 1).
- 4) The Utility Construction and Maintenance Department Manager may immediately suspend the LUSI, or recommend that the LUSI be suspended upon a stated future date, for an additional six months for any Violation occurring within one year of a reinstatement. Utilities will notify the LUSI of any immediate six month suspension or the six month suspension recommendation, including the date and time at which the suspension decision or suspension recommendation will be heard by the General Manager of the Utility Construction and Maintenance Department or their designee. The LUSI may appear and present evidence as to why the additional suspension should not occur. Prior to re-instatement of the LUSI after a suspension, the licensee must complete a re-instatement procedure. The re-instatement procedure following a suspension includes review of and compliance with all required components of the initial Utility Service Installer license procedure as listed in paragraph 3.02 a) 1).
- 5) Revocation of Utility Service Installer license will occur pursuant to the Code of the City of Colorado Springs when a LUSI has accumulated more than three Violations in a one year period; the LUSI experiences, or fails to notify Utilities of, a positive, refusal, or non-negative drug or alcohol test (as defined by 49 CFR Parts 40 and 199); or for any other reason provided for by the Code. Pursuant to Section 12.3.310 of the Code of the City of Colorado Springs re-licensing cannot occur until two years from the date of the revocation of the license. The post-deprivation appeal of a revocation decision will be heard by the General Manager of the Utility Construction and Maintenance Department or their designee. The LUSI may appear and present evidence as to why the revocation should not occur or why a suspension should be served in lieu thereof. Prior to re-instatement of the LUSI after a revocation, the licensee must complete the re-licensing procedure. The re-licensing procedure following a revocation includes review of and compliance with all required components of the initial Utility Service Installer license procedure as listed in paragraph 3.02 a) 1).

e) Fees:

- 1) An Inspection and Connection Fee as specified in Utilities' Tariffs will be paid by the Owner, Builder, Developer or Customer for the inspection and connection of the natural gas service line, electric service line or joint trench service lines (Colorado Springs Utilities Gas & Electric) prior to it being allowed to be scheduled with Colorado Springs Utilities for installation.
- 2) A Training Fee will not be charged for an initial Utility Service Installer License procedure, Knowledge, Skill and Licensing Assessment, OQ written examination and OQ task performance evaluation. When an applicant is required to retake a written exam (Knowledge, Skill and Licensing Assessment) pursuant to 3.02(a)(3) due to failure to achieve a passing score, a Retake Fee of \$250 will be charged. When training is required for re-instatement after suspension of the license, a Training Fee of \$250 will be charged.
- 3) There will be no Licensing or Drug and Alcohol Administrative Fees due to Colorado Springs Utilities by the LUSIs as part of this program.
- 4) The LUSI is responsible for all applicable Return Trip Inspection and Connections Fees as specified in Utilities' Tariff.
- 5) The LUSI is responsible for all applicable Cancellation Fees as specified in Utilities' Tariff.
- 6) Fees due from a Utility Service Installer licensee will be billed on a monthly basis. The Utility Service Installer's license will be automatically suspended when any bill for fees due remains unpaid after 30 days from the date of the bill's due date. Nonpayment of fees is grounds for revoking a Utility Service Installer license.
- 7) When required, welded natural gas service risers shall be approved, fabricated, and installed by the Colorado Springs Utilities. Costs to the builder will be based on a Time and Materials contract.

f) Records Management:

The Colorado Springs Utilities, Utility Construction and Maintenance Department will maintain records of test scores; Operator Qualification task evaluation; records of last inspected fusions; records of Insurance Certification; records of violations, suspensions and revocations, records of drug and alcohol program compliance, and records of license dates and license terms for all LUSIs. Records will be maintained as required by law.

This Page Left Intentionally Blank

TABLE OF CONTENTS

CHAPTER 4 Service Line Design and Construction

Paragraph Number	Title	Page Number
4.01	Introduction	4-2
4.01 a)	Service Line Repair or Replacement	4-2
4.01 b)	Service Line Relocation	4-3
4.01 c)	Gas Service Line to an Existing Structure that has Natural Gas Service	4-3
4.01 d)	Gas Service Line to a New Building or Existing Buildings that Have not Had Previous Natural Gas Service.....	4-3
4.01 e)	Gas Service Lines Being Killed	4-3
4.01 f)	Gas Service Line Excess Flow Valves	4-3
4.02	Pre-Installation Procedure	4-4
4.02 a)	Summary	4-4
4.02 b)	Service Line Sizing	4-5
4.02 c)	Service Design Checklist.....	4-5
4.03	Installation Procedures	4-5
4.03 a)	Summary	4-5
4.03 b)	Service Line Location	4-6
4.03 c)	Service Line Clearances	4-7
4.03 d)	Service Line Installation.....	4-8
4.03 e)	Leak Test Requirements.....	4-11
4.03 f)	Venting Through Pavement.....	4-12
4.03 g)	Mobile Home Lots	4-12
4.04	Inspections	4-13
4.04 b)	Special Conditions	4-14
4.04 c)	Re-Inspection.....	4-14
4.04 d)	Inclement Weather and Show Up Time	4-15
4.05	Fuel Gas Piping, Manifolds, and Gas Meters.....	4-15
4.05 a)	Fuel Gas Piping.....	4-15
4.05 b)	Meter/Riser Manifolds	4-16
4.05 c)	Above Ground Multiple Meter Manifolds	4-16
4.05 d)	Meter	4-18
4.05 e)	Gas Meter Testing.....	4-24
4.06	Materials.....	4-25
4.06 a)	Pipe and Fittings	4-25
4.06 b)	Risers.....	4-25

CHAPTER 4

Service Line Design and Construction

4.01 Introduction

Service line design and construction specifications are adopted as rules and regulations by Colorado Springs Utilities in accordance with Chapter 12, Article 3, Sections 12.3.301 and 12.3.304 of the Code of the City of Colorado Springs. The purpose is to ensure that requirements established in Colorado Springs Utilities Natural Gas Tariffs/Rules and Regulations, and the U.S. Department of Transportation Minimum Federal Safety Standards for Natural Gas Pipelines (49 CFR Part 192), are adhered to by all persons engaged in design and/or construction of natural gas service lines.

The scope of the following specifications include all new polyethylene gas service lines. Mainlines and related infrastructure are installed by Colorado Springs Utilities, Utility Construction and Maintenance Department or their contractors and follow internal design, installation, and operation standards and specifications (e.g., Design and Engineering Manual, etc.).

A Licensed Utility Service Installer (LUSI) shall only perform installation of the affected gas service lines that they are qualified in but in no instances shall be larger than 2 inches nominal diameter. LUSI's are limited to using socket fusion methods. The contractor and/or LUSI shall be held responsible for the integrity of gas service line installations for a period of 3 years beginning the day final approval is granted by the Colorado Springs Utilities, Utility Construction and Maintenance Department.

Colorado Springs Utilities Gas Construction personnel shall evaluate each of the following, on a case-by-case basis to determine the best course of action.

a) Service Line Repair or Replacement:

LUSIs are responsible to repair non-plumb risers for installations that they completed and that do not yet have a gas meter installed. Riser repairs must be made within 72 hours or 3 business days (whichever comes first) of notification by Colorado Springs Utilities. If repairs are not made within this timeframe, the LUSI will not be allowed to perform additional tie ins and the LUSI may be issued a violation, which could result in the temporary suspension of the LUSI's license. All other repairs or replacement of service lines and risers shall be completed by Colorado Springs Utilities and may be charged to the customer (e.g., LUSI, homebuilder, and/or others) on a Time & Materials (T&M) basis.

Per the requirements of the Colorado Public Utilities Commission as it pertains to non-residential service lines, "Service lines installed prior to 9/1/1984 which require repair or renewal due to leakage shall be repaired or renewed by the Division (Colorado Springs Utilities) at the owner's expense." In addition, for pre 9/1/1984 installed non-residential service lines, Colorado Springs Utilities will replace, at the owner's expense, substandard material not consistent with gas industry standards of that time period (i.e. installation of PVC pipe, clear plastic pipe, sprinkler hose, etc.).

b) Service Line Relocation:

Any residential or commercial relocation of service lines required due to customer actions is charged to the customer on a Colorado Springs Utilities T&M basis (Example: grade changes, new buildings/structures which jeopardize existing gas service lines). T&M contracts are initiated by Colorado Springs Utilities Field Engineering Section. Upon completion, the contract will be reconciled for actual costs.

c) Gas Service Line to an Existing Structure that has Natural Gas Service:

Work required for any structure that already has a natural gas service line and now requires the gas service line to be relocated, upgraded, replaced, to have additional risers installed, to have a branch service installed, or the gas meter to be moved for any reason, shall be performed by Colorado Springs Utilities Operator Qualified (OQ) personnel. The work required is charged to the customer on a Colorado Springs Utilities T&M basis.

(Note: A branch gas service line is a gas service line which intersects, attaches, and is fed from an existing natural gas service line.)

d) Gas Service Line to a New Building or Existing Buildings that have not had previous Natural Gas Service:

Colorado Springs Utilities LUSIs shall be allowed to install all new natural gas service lines for all brand new structures or existing structures, which require natural gas service and are creating new gas load. Plastic socket fusions shall be performed by the LUSIs in compliance with Colorado Springs Utilities Plastic Joining Procedure. Appendix F provides the socket portion of the approved procedure. Updates to this procedure may be necessary at times with some updates requiring an immediate change to the procedure. If this occurs, Colorado Springs Utilities, Utility Construction and Maintenance Department Quality Control Inspectors will distribute the updated procedure to the LUSIs.

e) Gas Service Lines Being Killed:

All natural gas service lines within Colorado Springs Utilities gas service area that are being killed, for the demolition of a building, home or structure, shall always be killed and capped at the designated property line of the address and an electronic marker placed at this location.

All natural gas service lines that are servicing any buildings, homes or structures within Colorado Springs Utilities gas service area, that are being demolished and no building, home or structure shall be rebuilt in its place, the lot or property is to remain vacant or may become a parking lot, and no longer requires natural gas service, the gas service line shall be killed and capped at the main.

f) Gas Service Line Excess Flow Valves and/or Service Valves:

Excess Flow Valves (EFVs) and/or service valves shall be installed on services as required by 49 CFR Part 192.381, 192.383 and 192.385. Installation of the EFVs or service valves

shall only be performed by operator qualified (OQ) Colorado Springs Utilities staff or operator qualified Colorado Springs Utilities contractors.

4.02 Pre-Installation Procedure

a) Summary:

The following summary may be used as a guide when designing a gas service line installation.

- 1) Contact Colorado Springs Utilities (719-668-3524) to request gas service, determine pressure available, and gas service stub location for the subject premises prior to installation of the gas service line.**
- 2) Contact Colorado Springs Utilities Field Engineering if any of the following situations occur:**
 - a) Lot(s) does not have an existing service stub. Field Engineering will determine the installation location of the gas service stub.**
 - 1) Scattered Services:** Per the Utilities Rules and Regulations, Utilities will provide only one Natural Gas Service Stub to each individual lot, that will extend to the property line where practical, provided a main is located in the street adjacent to the Premises, or will provide a Natural Gas Service Stub to the boundary of its easement when a main is located in an acceptable easement adjacent to the Premises.
 - 2) All necessary permits, fees and public right-of-way restoration costs will be paid by the Owner.**
 - b) Gas load requirements exceed 1,000,000 BTU/HR or as otherwise indicated on the sizing tables (see Appendix C). Note that an Application for Gas Service Line Approval (Chapter 2) is required for new residential gas service for any load over 1,000,000 BTU, a commercial gas service with any load, or any service where there is no stub to the property line.**
 - c) Structure is in a pressure district having pressure less than 56-inch water column pressure.**
 - d) Elevated delivery pressure is required.**
 - e) When converting from propane to natural gas.**
 - f) All branch gas service lines to a brand new and/or existing structure require a gas service design approval from Colorado Springs Utilities Field Engineering prior to installation. Additional fees may be applicable.**
- 3) Submit required site plan, building footprint and proposed meter location to Colorado Springs Utilities Field Engineering. Colorado Springs Utilities will not prepare the design drawing(s) without required site plan, building footprint and meter location.**

b) Service Line Sizing:

Gas service lines shall be sized according to guidelines provided in Tables 1 through 3 (see Appendix C). For gas loads or gas service line lengths greater than those included in the tables, contact Colorado Springs Utilities Field Engineering. For gas loads and service line lengths that fall between the values shown in the tables, use the next higher listed value. Each table clearly indicates which total connected load and service line length combinations must be sized by Colorado Springs Utilities Field Engineering.

- 1) Service lines that provide a total connected gas load exceeding 1,000,000 BTU/HR must be sized by Colorado Springs Utilities Field Engineering.
- 2) All service lines intended for installation at commercial/industrial sites shall be a minimum of 1-1/4 inch IPS polyethylene.

c) Service Design Checklist:

Colorado Springs Utilities Field Engineering requires one copy of the following information prior to preparing a design drawing.

- 1) Site plan showing the location of all property lines, driveways, sidewalks, planter box areas, and a “footprint” of the building(s) located on the property. The building “footprint” shall indicate the location of all opening windows, doors, and vents.
- 2) Location of outside electrical appliances, transformer(s) and electric meter(s).
- 3) Location of all existing and proposed underground facilities including drainage.
- 4) Location of existing gas service stub(s) as applicable.
- 5) Location of proposed gas meter(s) (see Figure 4).
- 6) The individual gas load for each existing and proposed gas appliance(s).
- 7) Address and street name of the building(s) to be served.
- 8) Name and telephone number of Applicant.
- 9) Detail drawing of multiple meter steel manifolds, as applicable.

*Any changes that have been made to the service design which has been approved, including, but not limited to the gas meter location, individual appliance load, total connected load, metering pressure, address or street number may delay the installation of the gas meter. We reserve the right to hold the installation of the gas meter and require you to resubmit the correct information to Field Engineering.

4.03 Installation Procedures

a) Summary:

The following summary may be used as a guide to accomplish installation tasks for gas service lines:

- 1) The typical residential service line installation utilizes a joint trench for both electric and gas services. NOTE: Joint trenching of electric and gas service lines shall only occur when an address being served resides within both Colorado Springs Utilities electric and gas service territories where both utilities are owned by Colorado Springs Utilities. The LUSI is responsible for providing the trenching, padding & backfilling, electric wire and gas service lines (see Table 7 for Approved Materials, Table 10 for Inspection Checklist, and Figures 1-9 for installation details).
- 2) LUSIs shall only install gas service lines smaller than or equal to 2” and only the sizes of pipe that they were tested on and passed qualification requirements.
- 3) 1-1/4" risers shall be installed for all commercial services unless an alternative is required by Field Engineering or Gas Advanced Design.
- 4) Prior to inspection, gas service line(s) shall be leak-tested with air in accordance with 4.03(e) Leak Test Requirements. Also, each gas service line trench shall be properly padded per 4.03(d) Service Line Installation notes 9 and 10.
- 5) The LUSI must contact Colorado Springs Utilities for an inspection (719-668-3524, option 1). See 4.04 Inspections, for inspection procedure. Questions and/or problems regarding gas service line inspections must be referred to Colorado Springs Utilities, Utility Construction and Maintenance Department (719-668-3524, option 1).
- 6) Upon approval of the LUSI’s installation through inspection by a Gas Construction Quality Control Inspector or a Colorado Springs Utilities qualified inspection contractor, the Colorado Springs Utilities, Utility Construction and Maintenance Department will energize (tie-in) the gas service line(s).
- 7) Once the service line(s) is approved, the LUSI installing the gas service line(s) shall be responsible for back-filling the gas service line(s) trench to existing or final grade at time of tie-in before the OQ qualified inspector leaves site. The final back-fill procedure should be completed within 24 hours from the time of tie-in to best protect services in the trench.
- 8) If the service riser and/or fuel gas piping inlet are not located by the LUSI such that a standard meter set can be constructed (see Figures 4, 5 & 8), the configuration will be rejected. Contact Colorado Springs Utilities Field Services (719-668-7350) for questions and/or problems with the rejection.
 - a) If the configuration is rejected due to the fuel gas piping, the Builder will be responsible to resolve the issue.
 - b) If the configuration is rejected due to the service riser, Colorado Springs Utilities will be responsible, unless the service riser location provided by the Builder proves incorrect at time of meter set, the Builder will be responsible.

b) Service Line Location:

Any utility service lines (other than communication as shown in Figure 1B) owned by any entity other than Colorado Springs Utilities are not allowed to be installed in a joint trench with

Colorado Springs Utilities owned natural gas service lines. See Figure 4B for non-Colorado Springs Utilities owned electric utility lot layout requirements.

1) Each gas service line shall be located within the property lines of the lot that is intended to serve. Utilities will provide only one Natural Gas Service Stub to each individual lot that will extend to the property line where practical. Each separate and/or additional structure/building shall be served by a single or separate gas service line, riser and meter where practical. Mainline extensions may be required onto a lot when there is more than one building on the lot. All gas service lines shall be installed in the most direct, straightest and practical path possible from the gas service stub location to the gas service riser and meter location. See 2.02c for Location & Clearances of Gas Main Line and Figure 4 for Utility Lot Layout.

2) Joint Trench:

Gas service lines installed in a joint trench with Colorado Springs Utilities owned electric and/or communication lines require a 12 inch minimum radial separation (see Figures 1 & 9, as well as the ELESS joint trench lot layout figures).

Joint trench is for residential applications. Commercial installations are not to be in a joint trench unless approved by Colorado Springs Utilities and joint trench shall not be used with the high-pressure distribution system (>76 psig).

3) Single Trench (Gas Only):

All gas service lines shall maintain the minimum required horizontal separation from other buried utilities, property lines and structures adjacent to the gas service line when installed in a gas only trench (Figure 1A). Gas service lines shall not be installed under structures such as walls, sheds, or other appurtenances for safety and ease of locating.

Where the required horizontal or vertical separation distance cannot be maintained or if the proposed route is determined by Colorado Springs Utilities to be unavoidable, an exception or a variance to a crossing standard may be requested. All exceptions or variances are to be submitted to the Gas Quality Control Supervisor and/or the Gas Construction Section Leader in written form with detailed documentation of the exact circumstances, terms, and conditions of conflict and proposed solution. Exceptions or variances from the required gas standards may only be approved by the Colorado Springs Utilities, Utility Construction and Maintenance Department Gas Quality Control Supervisor and/or the Gas Construction Section Leader.

If exceptions or variances are approved in cases where buried utilities and/or underground structures prohibit adherence to separation requirements, a polyethylene protective sleeve may be required. The protective sleeve shall have an inside diameter sufficient for insertion of the gas service line (and tracer wire) without causing undue resistance and shall be of the same material as the gas service line. A minimum one-foot vertical separation from the gas carrier pipe or protective sleeve to the structure footer shall be required for all unavoidable utility crossings. The protective sleeve shall extend a minimum of 3 feet beyond the perimeter of the conflicting structure.

c) Service Line Clearances:

Gas service lines should have the following minimum separations (see also Section 2.02c):

- 1) Minimum 3 foot horizontal separation from property lines, above or below ground structures, and/or other utilities.

EXCEPTION: Minimum 2'-6" (30 inch) horizontal separation from property lines, above or below ground structures, and/or other utilities, shall only be allowed where and when residential structures are built on less than a 6 foot setback from the side property line (distance of less than 6 feet between the side wall of the structure and the side property line). See Figure 4A.

- 2) Minimum one foot vertical separation when crossing other utilities.
- 3) Minimum 24 inch cover required.

Note: separations are measured from the outside diameters of the utility lines.

d) Service Line Installation:

Colorado Springs Utilities allows the use of prefabricated service line assemblies, but only for 3/4 inch service lines, and only where the line does not exceed a length of 120 feet. Prefabricated service line assemblies include an approved anodeless riser, up to 120 feet of factory-installed polyethylene gas piping, and tracer wire. LUSIs who install these types of lines need to self-inspect for gouges greater than 10 percent. A socket heat fusion is allowed on these lines. All socket heat fusions must be performed using tools and equipment maintained to manufacturer specifications. All fusions shall remain exposed and the trench shall remain open for inspection.

Steel gas service lines shall only be installed by the Colorado Springs Utilities, Utility Construction and Maintenance Department or their contractor. Trenching, padding & backfilling for all new services shall be provided by the builder's representative.

Boxed property line valves shall be installed by Colorado Springs Utilities or their contractor as required by 49 CFR Part 192. Property Line valves shall also be installed for new or replaced services 2" or larger or services designed for public assemblies including, but not limited to; schools, churches, hospitals, and nursing homes. Property line valves should be installed when commercial/industrial customers have significant amounts of private utilities that could impede construction crews during future gas work.

Any gas service line that is located within Colorado Springs Utilities natural gas service territory that needs to be relocated and or replaced after the initial installation, that has had natural gas being delivered through it to the point of sale (the meter) shall require any and all such work to be performed by Colorado Springs Utilities personnel.

NOTE: Colorado Springs Utilities, Utility Construction and Maintenance Department Quality Control Inspectors or Colorado Springs Utilities operator qualified inspection contractor will examine all trenches and padding. If any violation of the service line installation standard is discovered during an inspection, the Utility Service Installer's license may be suspended or revoked at the discretion of the Colorado Springs Utilities, Utility Construction and Maintenance Department.

- 1) All gas service lines shall be installed in the most direct, straightest and practical path possible from the gas service stub location to the gas service riser. Where field bends are

necessary, the radius of the bend shall not be smaller than specified in Table 4. Field bends that have fittings within the bend shall only be installed by Colorado Springs Utilities, Utility Construction and Maintenance Department or their contractor.

- 2) Gas service lines shall not be installed under any building/structure. Nor shall gas service lines or meters be installed within or under partially enclosed surface structures (e.g., tunnel) where gas from potential leaks can accumulate and access and maintenance are challenging. Underground and surface structures include, but are not limited to foundation and basement walls, patios or other sealed surfaces, which abut a building, or its foundation. Excluded from this category are unavoidable structures where a protective sleeve is required.
- 3) LUSIs fusing gas service line piping up to and including 2” diameter shall be joined by socket heat fusion only. Colorado Springs Utilities and their contractor may use socket, saddle, butt, or electrofusion.
- 4) All socket heat fusions shall be performed in accordance with Colorado Springs Utilities Plastic Joining Procedure (see Appendix F). If discrepancies exist between this document and the Plastic Joining Procedures, the Plastic Joining Procedures shall be implemented. Only persons who are LUSIs shall perform socket heat fusions and/or install prefabricated service line assemblies.
- 5) *NOTE:* Due to the thermal expansion & contraction of polyethylene, sufficient pipe length shall be provided by installer (polyethylene pipe changes in length one inch for every 100 feet for every 10 degrees Fahrenheit).
- 6) Cold weather (below 55°F) fusions shall be performed using the method detailed in the Colorado Springs Utilities Plastic Joining Procedure (see Appendix F). See 4.04(d) for Inclement Weather and Show Up Time explanation.
- 7) For gas service line(s) installed by LUSIs no more than 2 socket fusion couplings between the gas service stub and the gas service riser shall be allowed. Colorado Springs Utilities Gas Construction Quality Control Inspectors must approve the use of more than 2 socket fusion couplings. All couplings must be exposed for inspection. The minimum pipe lengths between adjacent socket fusions, except for those associated with field bends, are detailed in Table 6.
- 8) No gas service line shall be installed in an “over dig” area of a building foundation prior to it being completely backfilled and appropriately compacted. After the entire “over dig” area of the foundation is backfilled and compacted, a separate trench shall be dug for the installation of the gas only service line or joint trench service lines.
- 9) All gas service lines and risers shall be properly supported on well-compacted soil prior to back-filling.
- 10) Prior to back-filling, an approved padding material (bedding sand), equal to manufactured sand (see Table 7 for Approved Materials), shall be used to:
 - a) Line bottom (below pipe) of the Joint Trench and Gas Only service line trench with a minimum of six inches (6”) of approved padding material.

- b) Place over the pipe an additional 6 inches of approved padding material.
 - c) Backfill completely around both the Jbox and the temporary electric pedestal at the time when it is relocated from the property line and installed at the house or foundation.
- 11) The trench depth shall be adjusted such that the depth of the gas only service line is a minimum of 24 inches, 32 inches for joint trench with electric, and a maximum of 48 inches below existing grade and proposed final grade, including the required padding. The cover above the gas service line shall be provided over the entire length of the gas and electric service lines including the top layer of padding material as shown in Figure 1. See Table 11 for Minimum & Maximum Cover for Natural Gas Lines.
 - 12) All gas only service line trenches shall be a minimum of 12 inches wide throughout the vertical depth. Joint trench service line trenches shall be a minimum of 24 inches wide throughout the vertical depth (see Figure 1).
 - 13) Back-fill material shall be free of all foreign debris such as bricks, concrete, asphalt, wood, and trash that may damage the gas service line. Colorado Springs Utilities, Utility Construction and Maintenance Department reserves the right to excavate any and all service line trenches to ensure that post back-fill padding requirements have been met.
 - 14) A bell-hole shall be provided by the LUSI at the property line or easement line in order to facilitate the tie-in of the gas service line.
 - a) For 3/4 inch and one inch gas service lines the bell hole shall be a minimum of 4 feet long by 4 feet wide.
 - b) For 1-1/4 inch and 2 inch gas service lines the bell-hole shall be a minimum of 7 feet long by 4 feet wide.
 - c) The length and width are to be measured along the bottom of the bell-hole and centered about the existing gas service stub. All back-fill material shall be placed no closer than 2 feet from the edge of the bell-hole.
 - 1) The depth of the bell-hole for polyethylene facilities shall be 6 inches deeper than the existing polyethylene service stub.
 - 2) The depth of the bell-hole for all steel facilities shall be 12 inches deeper than the existing steel gas service stub.
 - 15) A minimum of 12 inches of the existing gas service stub shall be exposed during excavation of the bell-hole.
 - 16) If gas service stubs are damaged such that greater than 10 percent of the wall thickness is gouged, stripping back of the trench shall be required in order to replace the entire portion of damaged pipe.

NOTE: Contractor shall provide shoring or benching if depth exceeds 5 feet or warranted by soil conditions.

- 17) If gas service stubs are damaged, (including cuts, kinks, breaks and/or those that are leaking) the damage shall be treated as an emergency, call (719-448-4800). **ONLY** Colorado Springs Utilities, Utility Construction and Maintenance Department shall repair the gas service stub, at the expense of the LUSI.
- 18) All Colorado Springs Utilities, Utility Construction and Maintenance Department-owned electronic markers are to remain in the trench.
- 19) The new gas service line shall extend a minimum of 12 inches alongside the existing gas service stub and shall be at the same elevation as the end of the existing gas service stub. The existing gas service stub shall not be realigned or moved.
- 20) A #12 tracer wire (see Table 7) shall be installed with each gas service line. The tracer wire shall be taped to the gas service line in at least three locations and not to exceed 10 feet from each other. The tracer wire shall be brought above existing grade adjacent to the building side of the riser and taped securely in 3 places to the contour of the gas service riser. See Figures 5 & 6 for tracer wire installation details included on service risers and manifolds.
- 21) The tracer wire shall be continuous (without splices) except where a branch service exists, which makes it necessary to splice additional wire onto the gas service line tracer wire. Where splices are necessary, Colorado Springs Utilities, Utility Construction and Maintenance Department approved wire connectors shall be used. All gas service risers shall have tracer wire installed with the riser and adhere to Colorado Springs Utilities Operator Qualification requirements.
- 22) Where welded steel gas service risers are installed, follow the same tracer wire installation criteria for anodeless risers. Also, a one pound magnesium anode shall be thermite welded to the riser below grade. Tracer wire is not to be thermite welded to any steel riser.
- 23) The electric service wire in a joint trench installation with the gas service line shall not be installed until the Colorado Springs Utilities Gas Construction Quality Control Inspector arrives on site. The electric wire is provided by the LUSI. Additionally, in the event the electric service wire must be installed under a driveway, patio, deck or similar structure, a 2 inch (PVC SCH40) electrical rated (grey) conduit must be installed, extending 24 inches beyond both sides of the obstruction, with a utility-provided locator biscuit installed on each side of conduit for future locating purposes. See Table 7 for Approved Electrical Materials.
- 24) Refer to the Colorado Springs Utilities Electric Line Extension & Service Standards book for additional details.

e) Leak Test Requirements for New Construction:

The pressure gauge used by the LUSI for pressurizing the pipe shall be a test gauge with a range of zero to 300 pounds per square inch (psig) and shall be operational and in good working condition. Colorado Springs Utilities or its contractor performing the actual leak test shall use a calibrated gauge.

- 1) The leak tests for new services will be evaluated at a targeted starting point of 125 pounds per square inch, but it is acceptable to start at any pressure between 115 and 135 pounds

per square inch. Any pressure difference of +/- 1 pound per square inch, within the approved leak test time period, will be a failed leak test.

- 2) The pressure to which the gas service line is subjected shall be no more than 135 pounds per square inch. If a gas service line is pressurized over 135 psig, installer will be required to replace entire line including the riser.
 - 3) All gas service lines 2" diameter and smaller shall be leak tested for a minimum of 15 minutes for lengths less than or equal to 200' prior to tie-in. For pipe lengths greater than 200' air test for 15 minutes for every 200 feet in length (e.g., 201' to 400' test for 30 minutes; 401' to 600' test for 45 minutes, 601' to 800' test for 1 hour, etc.). When the gas service line is allowed to be installed with the prior approval of Colorado Springs Utilities Gas Construction Quality Control Inspections personnel prior to the gas service stub installation, the service line shall remain under leak test until a gas service stub is installed by Colorado Springs Utilities. When this occurs, the licensed Utility Service Line Installer shall be billed daily fees for Colorado Springs Utilities Gas Construction Quality Control Inspections personnel to check and affirm that leak test pressure is maintained, and that the gas service line has not been unknowingly damaged. NOTE: This is not the preferred process or method of installation.
 - 4) To help ensure a passing leak test, it is important to let the pump up air/medium stabilize before starting the leak test.
 - 5) Additional information on pressure testing requirements is detailed in the Gas Operations and Maintenance Manual, to include testing of mixed material pipe segments.
- f) Venting Through Pavement:**

Except as specified in this paragraph, gas service line(s) shall not be located below or pass through any underground or surface structure.

- 1) Where a structure abuts a building, a gas service riser vent shall be installed. As shown in Figure 2, the gas service riser vent shall consist of a 12 inch by 12 inch opening in the sealed or concrete pavement surface. Field conditions may allow for a 6 inch by 6 inch with approval of the Field Service Inspector. The top 6 inches of the gas service riser vent opening shall be fitted with dirt, loose gravel or rock, as outlined in Figure 2. Other gas service riser vents may be used only with prior approval from the Colorado Springs Utilities, Utility Construction and Maintenance Department.

g) Mobile Home Parks:

- 1) Request for gas main and service extensions for new mobile home parks will be installed per Chapter 2 "Gas Main/Service Stub Extensions". The work will be completed on a Line Extension Contract since new load is being added to the gas system.
- 2) Request for gas main and service extensions for existing mobile home parks that is currently being fed from a master meter will be installed per Chapter 2 "Gas Main/Service Stub Extensions". This work will be completed on a Time and Material Contract since no additional load is being added to the gas system.

- 3) In addition to other requirements detailed in this manual, a gas service line serving a mobile home lot shall be designed and installed in accordance with Figure 3. No more than 10 mobile home lots in a single mobile home park will be scheduled for inspections during a single business day.

4.04 Inspections

Colorado Springs Utilities Gas Construction Quality Control Inspectors or Colorado Springs Utilities operator qualified inspection contractor will inspect gas service line installations performed by LUSIs. For requesting a Gas Service Line Inspection contact Colorado Springs Utilities between 7:30 a.m. and 2:00 p.m., Monday through Friday, excluding holidays (see scheduling gas inspections in Phone Section). Appointments need to be scheduled a minimum of 3 business days before the requested appointment date, and no more than 3 weeks before the scheduled appointment date (see Table 9 for Appointment & Cancellation Criteria).

a) Prior to inspection, please note the following:

- 1) Colorado Springs Utilities Gas Construction Quality Control Inspectors may require guard posts, padding, protective sleeve(s) and/or venting, at their discretion.
- 2) All service line trenches will need to remain open for inspection, including all prefab riser and line assemblies.
- 3) Gas service line(s) will not be inspected until gas mains and service stubs have been installed.

EXCEPTION: Gas service line(s) associated with scattered service stub installation. Colorado Springs Utilities Field Engineering will determine the proper location of the service stub.

- 4) No gas service lines shall be installed prior to installation and energizing of gas mains and stubs.
- 5) Excavation of all gas service stubs shall be performed using careful probing with hand tools only.
- 6) Building/property address with street name must be visible.
- 7) Pipe and/or tracer wire must be of proper length.
- 8) Pressure gauge must be installed on the service line riser.
- 9) Padding must be 6 inches above and below the gas service line.
- 10) Yellow paint must mark the proposed gas service riser location at the building wall.
- 11) The gas service regulator must be greater than 3 feet from operable windows, vents, and sources of ignition (see Figure 9).
- 12) No more than 2 fusion couplings are permitted on a service line when installed by LUSIs; one at the riser pigtail and one along the length of the service line. Colorado Springs

Utilities Gas Construction Quality Control Inspectors must approve the use of more than 2 socket heat fusion couplings and shall only do so if the service line exceeds 500 feet in length or if there are extenuating circumstances as determined by the Colorado Springs Utilities Gas Construction Quality Control Inspector that require more fittings to be used.

- 13) The trench and bell hole must be cleaned out and leveled.
- 14) Field bends of the service line must meet the minimum bending radius requirements (Table 4).
- 15) A required minimum one foot of gas service line must be exposed in the bell-hole, centered with at least 2 foot of clearance on each side of the service stub. Also, 6 inches of clearance is required below all polyethylene stubs and 12 inches of clearance below all steel stubs.
- 16) Utility crossings require a minimum of one foot vertical separation, and 3 feet horizontal separation for parallel facilities.
- 17) All utility locations must be dimensioned from property lines, building lines, or other permanent landmarks.
- 18) When gas, electric, and communication lines are approved to be in the same trench, a 12 inch radial separation must be maintained.

b) Special Conditions:

Colorado Springs Utilities, Utility Construction and Maintenance Department reserves the right to grant partial inspections of gas service line(s) for flag lots. A gas service line may be extended up to the flag portion of the lot only if Applicant has obtained Colorado Springs Utilities, Utility Construction and Maintenance Department approval and water and sewer services have been installed.

Special conditions may warrant a partial inspection of gas service line(s) in order to allow for paving installation prior to final approval and tie-in of the completed gas service line(s). Colorado Springs Utilities, Utility Construction and Maintenance Department must pre-approve this type of installation.

Under certain circumstances where service lines cannot be installed prior to installation of retaining walls, driveways, etc., a protective sleeve may be required. This sleeve, and its intended use, must be approved by Colorado Springs Utilities prior to installation.

c) Re-Inspection:

If gas service line(s) fails to pass inspection, the Colorado Springs Utilities Gas Construction Quality Control Inspector will present an Inspection Checklist to the LUSI with the rejection issues listed. All deficiencies must be corrected/remedied before a re-inspection may be requested and scheduled (see Table 10 for Joint Trench Inspection Checklist). Contact Colorado Springs Utilities to schedule re-inspection (see scheduling gas inspections in Phone Section).

d) Inclement Weather and Show Up Time:

In the event that inclement weather is encountered, Colorado Springs Utilities has adopted Academy School District 20's weather cancellation policy when it comes to determining when it is appropriate to cancel scheduled gas and electric service line inspection and tie in appointments due to inclement weather. Should Academy School District 20 cancel school due to inclement weather, all Colorado Springs Utilities gas / electric service line inspection and tie-in appointments scheduled for that day will be cancelled and moved out to the following day. For example, if appointments are cancelled on Wednesday, Wednesday's appointments will be moved to Thursday, Thursday's appointments will move to Friday and Friday's appointments will move to Saturday. If that schedule does not work for the LUSI they will be afforded the option of cancelling and rescheduling their appointments for a future date and time, per availability of appointment time slots. PLEASE NOTE: Should a delayed school start time announcement be made by Academy School District 20, this shall in no way affect or change the start times of your scheduled gas / electric service line inspections and tie-in appointments for that day.

Utility Service Line Installer shall not be entitled to any reimbursement from Colorado Springs Utilities. When Colorado Springs Utilities contacts the Utility Service Line Installer prior to starting the scheduled work day, and Colorado Springs Utilities has determined that weather conditions will not allow for a productive work day, no reimbursement shall be due to the Utility Service Line Installer for any show up time.

4.05 Fuel Gas Piping, Manifolds and Gas Meters

a) Fuel Gas Piping:

1) Location:

The fuel gas piping inlet shall be located above ground from the meter outlet and into the primary structure wall in accordance with Figures 6, 8 & 9, unless an approved Above Ground Multi-Meter Manifold is installed (see Figure 7). The required horizontal spread from the riser valve to the fuel gas piping inlet entering the primary structure wall is shown in Figure 8 and eliminates buried customer piping (see Chapter 1).

2) Elevated Pressure:

All elevated pressure requests must be made prior to installation of fuel gas piping to ensure adequate distribution system pressure is available. Elevated pressure requests can be initiated by contacting Colorado Springs Utilities Field Engineering. All elevated pressure installations shall be adequately labeled or tagged with the words "Elevated Pressure". Elevated pressure requests over 2 psig must include documentation from equipment manufacturer showing need for requested pressure (see Chapter 2 for form). Colorado Springs Utilities reserves the right to deny elevated pressure if the gas system doesn't have adequate pressure to serve the customer or if the customer owned facilities is deemed unsafe.

If changes are made to the total connected load that has been approved, Colorado Springs Utilities reserves the right to require a new application be submitted before the gas meter is installed.

- 3) All remodels that require a larger meter need to have the gas service line size re-evaluated by a Colorado Springs Utilities Field Engineer.

b) Meter/Riser Manifolds:

1) Location:

All gas service risers shall be located and installed in accordance with Figures 2 through 9 as applicable. Each gas service riser shall serve only one meter unless an Above Ground Multiple Meter Manifold assembly has been formally approved by Colorado Springs Utilities (see Figure 7). The intended gas service riser shall be clearly indicated by a yellow paint mark on the structure foundation prior to service line installation.

2) Prefabricated, Welded, and Below Ground Multiple Meter Manifold:

Prefabricated polyethylene-insert type anodeless gas service risers shall not be bent or altered. Heating or welding of polyethylene-insert type anodeless gas service risers is prohibited. All gas service risers and gas service line connections shall be properly supported on well-compacted soil to prevent damage during back-filling and compaction, and to prevent settling. Compaction shall be completed using either hydraulic or pneumatically operated equipment and shall be completed up to the surface level of the bottom of the riser. After back-filling, the gas service riser shall be in a vertical position. The minimum depth of the entire Manifold assembly shall be 24 inches.

- 3) All 1-1/4 inch and larger risers shall have a bypass installed.

EXCEPTIONS: Buildings with multiple risers shall have a bypass installed every 10 to 12 feet, instead of every riser. If the distance between the risers on the underground manifold exceeds 12 feet, a bypass shall be installed on every riser.

- 4) All welded gas service risers and welded steel multiple meter manifolds shall be field wrapped in accordance with Figure 11.
- 5) All polyethylene multiple meter manifolds shall be constructed and installed in accordance with Figure 6. Horizontal stair stepping or vertical stacking of multiple meter manifolds is prohibited unless Above Ground Multiple Meter Manifold assemblies have been formally requested by the LUSI, Developer, and/or property owner, and approved by the Colorado Springs Utilities, Utility Construction and Maintenance Department (see Figure 7). All gas service risers shall extend in a straight and perpendicular fashion from the manifold header.
- 6) Every effort shall be made by LUSIs to utilize prefabricated anodeless risers or polyethylene multiple meter manifolds.

c) Above Ground Multiple Meter Manifolds:

1) Request Procedure:

- a) Requests for Above Ground Multiple Meter Manifold systems will only be considered for structures intended to serve 3 or more individual tenants, owners or occupants. Residential Above Ground Multiple Meter Manifold systems (no commercial aboveground manifolds allowed) will be considered if the following requirements are

met:

- An approval from Colorado Springs Utilities Field Engineering
 - An approval from Colorado Springs Utilities Field Services
 - No meter with a load that exceeds 390,000 BTU's shall be allowed on a manifold. It shall have an individual gas riser.
 - All meters on the same manifold are required to have the same delivery pressure.
 - If any unit was to be leased that would require a load to exceed 390,000 BTU's, all costs of adding another riser would be the developer or contractor's responsibility.
 - All house lines would need to be identified with a brass tag stating address number and unit number.
 - The signed agreement would need to be on file before the gas inspection would be approved for meters.
- b) Submit to Colorado Springs Utilities Field Engineering a fully dimensioned project drawing indicating all building footprints, proposed meter set locations, proposed number of meters per set location, electric meter locations, air supply/heating vents, and other sources of migration and/or ignition.
- c) All fuel line and riser configurations must be constructed according to the dimensional requirements indicated in Figure 7, unless otherwise specified in writing by Colorado Springs Utilities.
- d) All gas service lines shall be constructed according to the specifications of the currently approved Colorado Springs Utilities Gas Line Extension and Service Standards Manual. However, the polyethylene service line diameter may be specified by Colorado Springs Utilities Field Engineering. Gas service line installations will be individually inspected for workmanship throughout installation process.
- e) All anodeless risers for Above Ground Multiple Meter Manifold assemblies shall be 1-1/4 inch, unless otherwise specified.
- f) All fuel lines through structure walls shall be black iron threaded piping unless otherwise specified in writing by Colorado Springs Utilities Field Engineering. House lines shall be secure and level and shall be one continuous pipe with no fittings.

All fuel lines are required to be labeled with a stamped brass tag attached with #12 wire which clearly identifies the premise it serves. If incorrect tagging or addressing creates inaccurate information in Utilities records, the owner of such premises will be responsible for actual time and material charges incurred by Utilities to correct the situation. The resolution of billing inaccuracies due to incorrect tagging or addressing will be the responsibility of the Owner and the Customer or user.

- g) After a request has been approved and the requester has completed construction of the fuel line and riser configuration according to Figure 7, and/or other specified dimensions required by Colorado Springs Utilities Field Engineering, the requester must initiate the meter set assembly by calling the Colorado Springs Utilities Field Services (719-668-7350). This process will include an inspection for adherence to applicable dimensional requirements. The inspection will be scheduled after a Gas account from Colorado Springs Utilities, System Extensions and a Final Heating Inspection from the Regional Building Department have been obtained for each building unit to be served.

- h) The Colorado Springs Utilities Field Services will provide all meter set assembly materials with the exception of the service line, riser and fuel lines.
- i) After installation of an Above Ground Multiple Meter Manifold, any elevated pressure and/or gas load increase requests may require the construction of a new and separate service line and meter set. Since all meters on the manifold assembly must operate at the same pressure, an elevated pressure would require the entire manifold to operate at the proposed elevated pressure. The cost associated with additional construction shall be borne by the owner or tenant of the structure requesting elevated pressure and/or a load increase. All elevated pressure installations shall be adequately labeled or tagged with the words “Elevated Pressure”.
Note: Before the lock is removed from the gas meter manifold a permanent address is required for each separate premise.

If addresses are changed after the Certificate of Occupancy has been issued, the owner of such premises will be responsible for actual time and material charges incurred by Utilities to correct the situation. The resolution of billing inaccuracies due to changes in addresses will be the responsibility of the Owner and the Customer or user.

d) Meter:

Colorado Springs Utilities meters will be sized and installed according to current load. Future loads will be re-evaluated as appliance(s) are inspected and approved by Regional Building. The final meter size shall be determined by Colorado Springs Utilities Field Services.

1) Residential Gas Meter:

- a) On single family residential construction where the total connected load is 390,000 BTU/HR or less, a gas meter bar/meter will be installed (3/4 inch and one inch risers only). Field Service will lock the meter valve off at the time of the installation if all three of the following conditions have not been satisfied. Lock will be removed after all are completed:
 - 1) Heating inspection or construction meter inspection is completed by Pikes Peak Regional Building Department (719-327-2883)
 - 2) The property owner has set up an account with the Customer Service Department for billing (719-448-4800)
 - 3) The site has been inspected by a Field Service Inspector (719-668-7350).
- b) Field service will make the final connection from the outlet side of the gas meter bar/meter to the fuel line stub.

2) Commercial Gas Meter:

- a) Commercial gas meters or gas meters with a total connected load greater than 390,000 BTU/HR will only be installed by Colorado Springs Utilities Field Services after the following three things take place:

- 1) Heating inspection or construction meter inspection is completed by the Regional Building Department (719-327-2883)
- 2) The property owner has set up an account with the Customer Service Department (719-448-4800)
- 3) The site has been inspected by a Field Service Inspector (719-668-7350).

*All commercial gas meter sets require a minimum 1-1/4 inch riser. The riser shall be installed 16 to 18 inches out from the final exterior finish of the structure.

- b) For additional commercial meter equipment see Figures 12 & 13.
- c) The Field Service Inspector will determine estimated facility gas loads for developer refund calculations and meter sizing. A Utilities Service Specialist from Colorado Springs Utilities Field Services will then install the new meter if the following conditions are satisfied.

3) Meter Set Location:

- a) All gas meter sets shall be in an outside location adjacent to a building easily accessible for gas meter reading and maintenance. Enclosures are not allowed, unless approved by Colorado Springs Utilities for safety reasons and the enclosure does not interfere with meter communications.
- b) Required Colorado Springs Utilities single family residential natural gas meter location for new construction is on the side of the structure and within 1 foot minimum and 5 feet maximum of the front corner of the structure closest to the gas main, or on the front wall of the structure facing typical public access, or that which is nearest to the gas main. Placement of the meter in this location is for the safety of Colorado Springs Utilities' staff that need access to the meter for periodic leak search and maintenance, emergency shutoff, and other activities. Accessibility, also therefore, impacts the safety of the residents. All meters on townhomes and single family residential buildings shall be easily accessible for maintenance with no enclosures or fencing. It is preferred to have both the natural gas and electric meters located on the same side of the structure. See Figure 4A.
- c) Construction Heat: A construction meter will not be allowed unless the customer meets with Colorado Springs Utilities Field Engineering and receives a Non Standard Meter Loop agreement form. This will be determined on a case-by-case basis.
- d) All gas meter sets shall be in accordance with the following requirements:

1) Primary Structure:

- a) A separate gas meter location shall be provided for each building, unit or structure which can be individually separated by sale or lease unless Multi-Meter Above Ground Manifolds have been formally requested by the LUSI, Developer and/or property owner and approved by Colorado Springs Utilities. Each separate structure shall have a plainly visible address attached, as applicable.

- b)** All gas service risers are to be located such that the service regulator vent will be at least 3 feet radially from any potential source of ignition (to include electric meter socket and panel), doorway, electrical device, garage door, electrical outlet, operable window, or any opening to the structure, as outlined in Figure 9 [per UPC 1209.6(c), DOT 192.353(c), 49CFR192.355, 356, and chapter VII Office of Pipeline Safety]. The service regulator vent will be typically located at the same height as the fuel gas inlet piping.
- c)** All gas service risers are to be located such that the service regulator vent will be at least 3 feet from any forced air intake/exhaust vent (including dryer vents, foundation vents, fireplace makeup air inlets and/or sump pump outlet drains), as outlined in Figure 9. All fresh air opening location clearances shall be located per local codes and IMC 401.4.
- d)** All gas meter loops shall be located a minimum of 6 inches to the right or left from decks, stairways, or other objects which may interfere with gas meter reading or maintenance. Sprinkler stubs, irrigation lines and hose bibs shall not be located above, behind or within 18 inches left or 6 inches right of the meter loop. A 3 foot meter clearance needs to be maintained from openings and electrical sources (Refer to Figure 9 for additional clearances). No gas meters shall be installed at an alley or property line.
- e)** As a condition of utility service, it is necessary for Utilities to have access to the final gas meter location at all times for the purpose of:
Installing, constructing, renewing, replacing, removing, relocating, operating, maintaining, reading, inspecting, repairing, testing and test upgrading of any portion of the distribution system located on or within the boundaries of the premises. Gas meter loop locations shall be located where there is minimum slope between the riser and house line (to be determined by the Field Service Inspector). Final grade from meter loop in all directions shall be no more than 3” drop per one linear foot.

Trimming or removing vegetation or other obstructions may be required if we determine there is a safety hazard or access issue which interferes with the operation or maintenance of the gas meter or associated piping, including, but not limited to, retaining walls, enclosures, and landscaping.

- f)** Any carport, porch, or patio designed to be installed over any Colorado Springs Utilities meter and/or service line is to remain open on 3 sides with protective guard posts (bollards) installed around the meter/service line, as shown in Figure 10.
- g)** All gas meter sets shall be located clear of direct water contact from sprinklers and/or roof runoff to include gutters and roof drains. Where it is impractical to avoid roof runoff, gas meter sets shall be covered by a means approved by the Colorado Springs Utilities Field Services. All gas meter sets shall be located such that no part of the set obstructs any portion of a passageway, access or stairway.
- h)** All gas meter sets shall be located clear of vehicular traffic. Where it is impractical to avoid vehicular traffic or the meter is to be installed within 3 feet

of a curb, parking lot or vehicular thoroughfare, the gas meter set shall be protected by approved guard posts (bollards) installed in accordance with Figure 10. Bollards shall be installed before the lock is removed. All meters located in “drive through” areas shall be approved by Colorado Springs Utilities Field Services. Meters shall not be located in the traffic area of a loading dock.

- i) The minimum distance that padmount transformers and generator equipment may be located from any part of a gas meter, gas regulator, or gas meter piping is 15 feet (see ELESS 18-227 for exceptions for natural gas generators). This distance may be reduced to 6 feet minimum if a solid masonry wall is built between the two. The minimum distance from the masonry wall to the gas meter, or any portion of the meter set piping, shall not be less than 3 feet. The masonry wall must be made of reinforced concrete, reinforced brick, or reinforced concrete block, with a minimum 3 hour fire rating. The wall must be at least twice the width of the transformer or generator, and at least 6 feet tall. If the generator equipment is greater than 6 feet in height, the wall must be equal to or greater in height than the equipment. The wall shall be anchored to the footing to withstand a minimum of 5 lbs. per square foot of wind load, and meet all applicable local building codes. See Colorado Springs Utilities Electric Distribution Construction Standards, 18-227, Note 2.
- j) Gas meter sets located near a Fire Department Connection (FDC) must be no closer than 3 feet to the left or right (not above) of the subject FDC.
- k) The gas fuel line piping inlet shall be located above ground from the meter outlet to the primary structure wall it is serving. This must be a continuous pipe with no fittings (i.e., couplings)
- l) Elevated Pressure: All elevated pressure requests must be made prior to the installation of fuel gas piping to ensure adequate distribution system pressure is available. Elevated pressure requests can be initiated by contacting Colorado Springs Utilities Field Engineering (form in Chapter 2). All elevated pressure installations shall be adequately labeled or tagged with the words “Elevated Pressure”.
- m) Added gas load tie ins will be inspected by Colorado Springs Utilities Field Services. Tie in location will not be accepted unless tie in point is outside the Colorado Springs Utilities meter loop (see Figure 8). Colorado Springs Utilities meter bypass will not be approved as a tie in point (see Figure 8b). All house lines will be secured and level before tie ins will be accepted. Compression fittings are prohibited to tie in added loads.

2) Additional Structures:

Each separate, additional, structure shall be served by a single and separate gas service line, riser and meter where practical. If a property **cannot be separated by sale or lease** and a separate gas service line, riser and meter are impractical and downstream underground piping from the primary meter to additional buildings is required, the following is required **before Colorado Springs Utilities will set a meter:**

- a) A detailed map showing all additional structures and the underground fuel gas piping.
- b) A piping inspection (air test) approved by Regional Building Department or the Code Official who has jurisdiction.
- c) Review of the "Natural Gas Customer Buried Piping Safety Notice" fact sheet, making the property owner aware of their responsibility to leak survey and monitor for corrosion on the downstream underground fuel piping located on their property (corrosion protection is required for steel piping). It is crucial that the property owner is aware that they will be held liable for any incident that occurs on this piping.

The "Natural Gas Customer Buried Piping Safety Notice" information is located on the Colorado Springs Utilities website at <https://www.csu.org/Pages/gas-lines-and-responsibilities-r.aspx>, the Pikes Peak Regional Building Department website at www.pprbd.org, and in Chapter 1 of this document.

Please refer to The Code of Federal Regulations (CFR) Sections:

- 192.12 – Customer Notification
- 192.465 – External Corrosion Control; Monitoring
- 192.723 – Distribution Systems; Leakage Surveys

4) Additional Requirements:

- a) A concrete gas meter pad (24”x 30”x 4”) shall be installed for all gas meters serving total connected gas loads of 1,400,001 BTU/HR and larger unless otherwise specified by the Colorado Springs Utilities Field Service Department.
- b) When numbering or lettering schemes are changed and/or incorrect tagging creates inaccurate information in Colorado Springs Utilities records, the owner of such premises shall be responsible for actual Time and Materials fees incurred by Colorado Springs Utilities in order to correct the situation.
- c) Except as allowed by Colorado Springs Utilities, new Master Meters and/or new Master Meter Systems shall be prohibited. Exceptions include assisted living, student housing, apartment buildings (where space for individual meters is not sufficient) or other similar purposes and must be approved by Field Services and Field Engineering, as Master Meters are considered a last resort. At least one meter per building is required. A master-metered customer may “check meter” tenants, lessees or other persons to whom ultimately the gas is distributed by an allocation procedure, provided the master-metered customer does not receive more than necessary to pay the master-metered bill. Colorado Springs Utilities will supply and maintain only the one master meter in such an instance. In addition, per the International Fuel Gas Code and as regulated by Regional Building Department, access to a separate shutoff valve must be provided to each tenant.
- d) A non-standard loop agreement is required on any residential, commercial or industrial gas meter loop that deviates from the following specifications as set forth in this manual (see form at the end of Chapter 2 & Figure 6):

- 1) Horizontal distance from the gas service riser to the finished exterior building wall
 - 2) Horizontal distance from the gas service riser to the fuel gas piping inlet
 - 3) Vertical distance from the gas service riser to the fuel gas piping inlet
 - 4) Vertical distance from finish grade to the top of inlet shut off valve and,
 - 5) If the total connected load meets or exceeds 910,001 BTU/HR and meter dimensions require the set to be right-to-left.
- e) When a gas service line has been disconnected and the gas meter is found to be located at an unacceptable location, such as the property line, the gas meter shall be relocated in accordance with these specifications before service is re-instated.
 - f) Gas meters may be situated in “meter banks” where more than one building unit is served within a single building and only when approved by Colorado Springs Utilities Field Service Department. Each fuel gas piping inlet shall be tagged with an approved brass tag, affixed with #16 gauge metal wire, which indicates the address served by the fuel gas piping. Gas meters will not be installed until all gas meter loops are properly tagged.
 - g) Gas meters, regulators, and piping may be painted; however, the meter index shall not be painted. In addition, nothing can be attached to gas meter and piping.
 - h) Back Up Generators for Commercial Properties
 - 1) If a natural gas backup generator is required, contact Colorado Springs Utilities Field Engineering to determine if a separate gas service line, riser and meter are required.

5) Additional Requirements for School Meters:

The gas meter for a school is set by Colorado Springs Utilities Field Services after the following conditions take place (all must be met):

- a) Colorado Springs Utilities Field Engineering has received and approved a fully dimensional project drawing indicating **ALL** primary- structure and modular(s) building footprints with the proposed meter set locations.
- b) A final piping inspection (air test) has been completed on the interior fuel line and approved by the code official who has jurisdiction. Typically, this is either the State of Colorado or The Pikes Peak Regional Building Department.
- c) An account for billing has been created by Colorado Springs Utilities Customer Services Department.

A separate billing address is required for each separate building, modular or structure.

- d) Service Line has been tied-in.

- e) A gas meter loop inspection has been completed along with an itemized load breakdown. This inspection is completed by a Colorado Springs Utilities Industrial Gas Fitter.
 - 1) At the time of the meter loop inspection if you have encountered difficulties in carrying out the requirements of these specifications, the Field Services Industrial Truck has the authority to grant modifications for individual cases provided you have exhausted every option available to you. The details for requesting the modifications must be in writing on the non-standard loop agreement form.
 - 2) The modification(s) will be rejected if it is determined they have the potential to create a safety hazard, lower the integrity of Colorado Springs Utilities gas distribution system or create unnecessary work for Spring Utilities personnel.
- f) Permanent meter protection is in place:
 - 1) A 6 foot high fence with a 6 foot by 6 foot access gate opening (this is mandatory).
 - 2) Guard Posts – (only when meter is in a location of vehicular traffic)
- g) The gas service riser, gas meter and fuel line piping shall be secured in a protected area by the following:
 - 1) Gas meter sets located at all schools shall have a 6 foot high fence with a 6 foot by 6 foot access gate enclosing the gas meter set. The meter set shall be located adjacent to a building. Minimum clearance of 3 feet is required from the front of the meter to the fence for meter maintenance.
 - 2) For the safety of all Colorado Springs Utilities’ employees who need access to the protected area for any gas meter related work a service road needs to be provided for a vehicle to get as close as possible.
- h) Back Up Generators for Schools:
 - 1) If a natural gas backup generator is required, contact Colorado Springs Utilities Field Engineering to determine if a separate gas service line, riser and meter are required.

6) Re-Inspection Fees:

- a) A graduated fee will be assessed for **ALL** repeat inspections. Absence of a visible address with a street name at the inspection location will result in a fee for re-inspection. In the absence of permanent street name signs, a temporary street name sign will be required.

e) Gas Meter Testing:

- 1) Acceptance testing for new gas meters:
 - a) All new gas meters received by Colorado Springs Utilities are certified and tested by the manufacture for accuracy.

- b) Colorado Springs Utilities performs a sample test of 10 percent of all new residential gas meters to verify accuracy. Residential gas meters must be plus or minus 1.0 percent accurate to pass the acceptance testing.
 - c) Colorado Springs Utilities performs a sample test of 100 percent of all new commercial and industrial gas meters to verify accuracy. Commercial and industrial gas meters must be plus or minus 1.0 percent accurate to pass the acceptance testing.
 - d) All rebuilt or repaired gas meters will follow the same accuracy limits as denoted in 4.05(e)1b & c before being placed in service.
- 2) Gas Meter Periodic Test Schedule:
- a) Gas meters not tested since original acceptance test will be periodically tested. Gas meters must be plus or minus 2 percent accurate to pass the periodic test.

4.06 Materials

All materials covered in this manual shall be new and free from obvious or visible defects and shall conform to the Colorado Springs Utilities Natural Gas Material Specifications. Materials approved for use in gas service line construction are detailed in Table 7.

a) Pipe and Fittings:

Polyethylene pipe and fittings shall be limited to those listed on Table 7 and shall bare all pertinent markings as specified in the Colorado Springs Utilities Natural Gas Material Specifications for polyethylene pipe and fittings.

All MDPE polyethylene pipe and fittings shall be free of material defects and the manufactured date is less than 3 years prior. HDPE fittings shall have manufactured dates of less than 10 years prior. Sections of pipe with gouges deeper than 10 percent of wall thickness of the pipe shall be removed and replaced.

b) Risers:

All gas service risers shall be approved prefabricated polyethylene-insert type anodeless risers as noted in Table 7, unless fabricated by Colorado Springs Utilities. All gas service risers larger than 2 inches shall be welded steel risers fabricated by Colorado Springs Utilities Machine Weld Shop and installed by Colorado Springs Utilities, Utility Construction and Maintenance Department or its contractors. 1-1/4" risers shall be installed for all commercial services unless an alternative is required by Field Engineering or Gas Advanced Design.

This Page Left Intentionally Blank

TABLE OF CONTENTS

Appendix A Colorado Springs Utilities Service Area Maps

Chapter Number	Title	Page Number
A.1.0	Introduction and Index.....	A-2
A.1.1	NW Quadrant Map.....	A-3
A.1.2	NE Quadrant Map.....	A-4
A.1.3	SW Quadrant Map.....	A-5
A.1.4	SE Quadrant Map.....	A-6

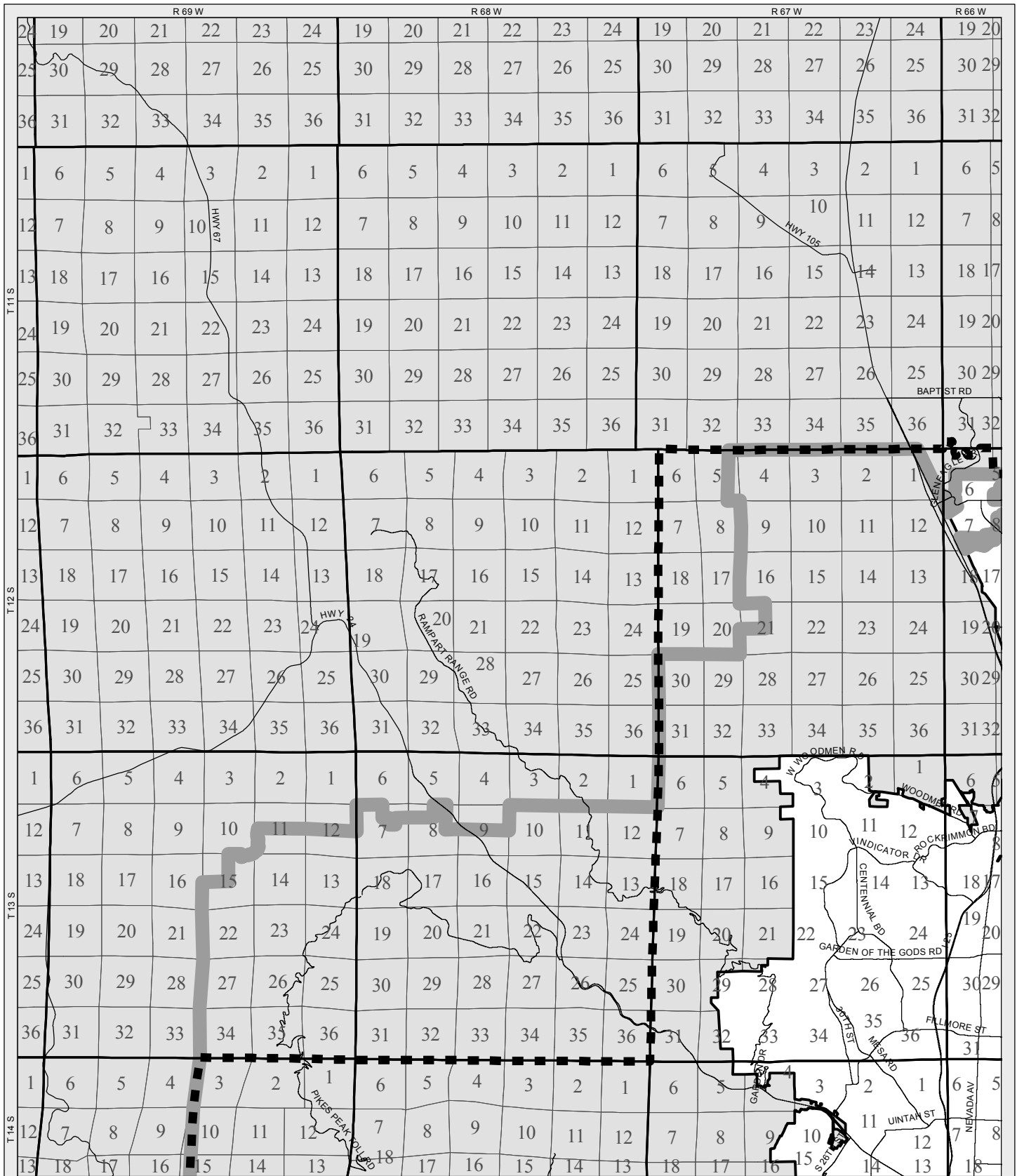





Colorado Springs Utilities
It's how we're all connected

Scale 1" = 14000'



Legend

-  Electric Service Area
-  Gas Service Area
-  Colorado Springs Boundary
-  Section Lines
-  Township/Range Lines

Colorado Springs Utilities
Service Area Boundaries

Page A-3

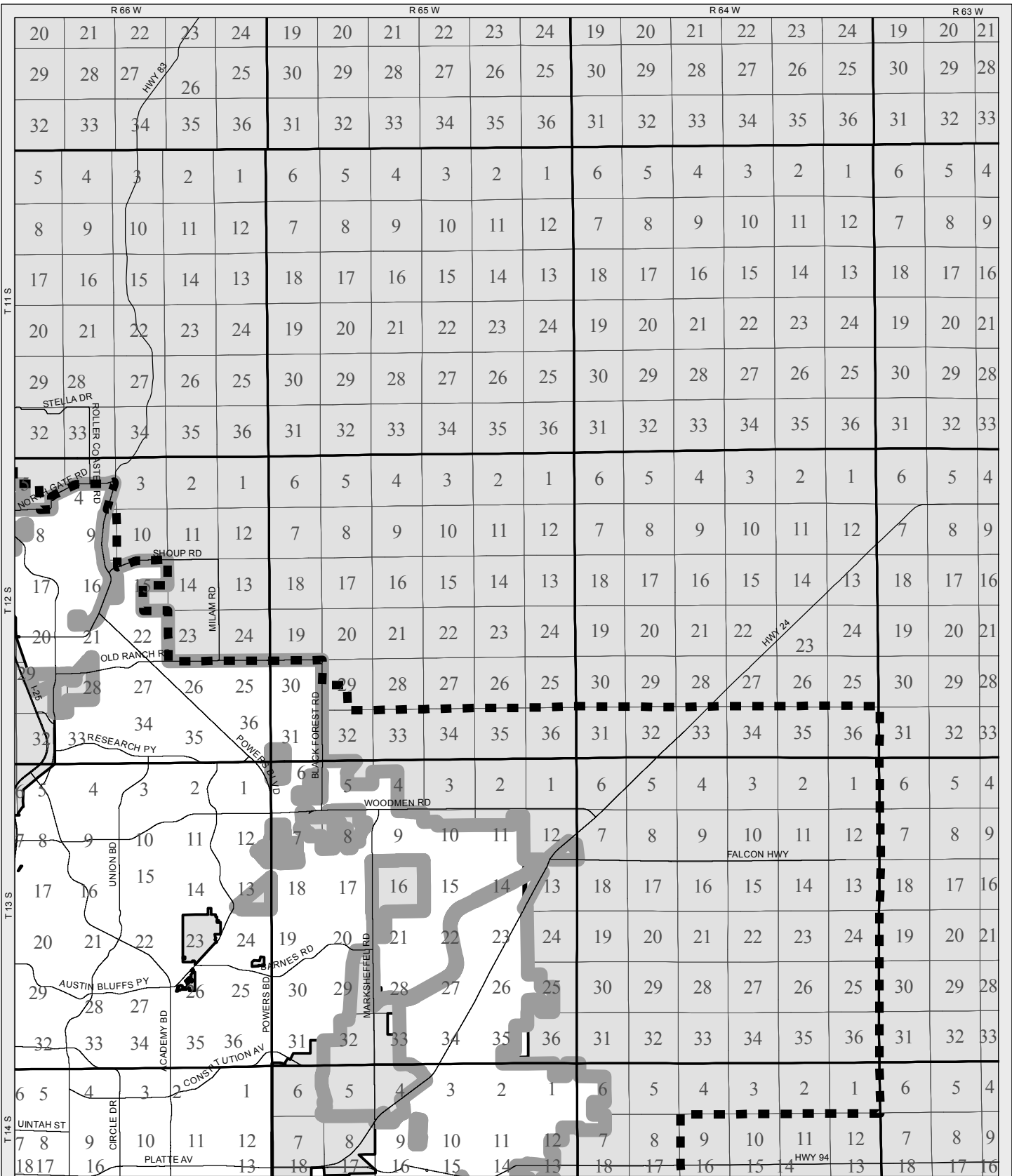





Colorado Springs Utilities
It's how we're all connected

Scale 1" = 14000'



Legend

-  Electric Service Area
-  Gas Service Area
-  Colorado Springs Boundary
-  Section Lines
-  Township/Range Lines

**Colorado Springs Utilities
Service Area Boundaries**

Page A-4

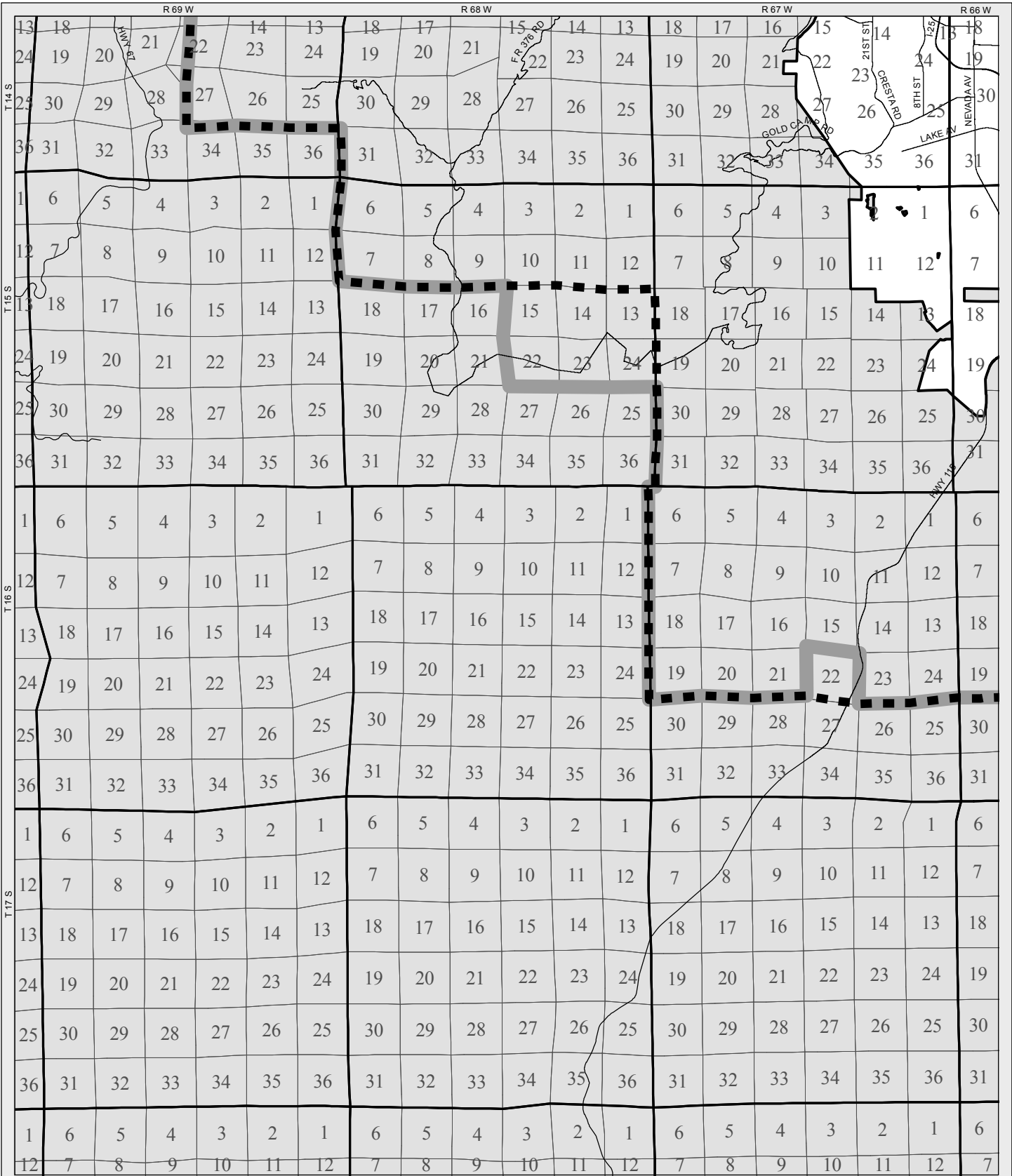





Colorado Springs Utilities
It's how we're all connected

Scale 1" = 14000'



Legend

-  Electric Service Area
-  Gas Service Area
-  Colorado Springs Boundary
-  Section Lines
-  Township/Range Lines

Colorado Springs Utilities
Service Area Boundaries

Page A-5

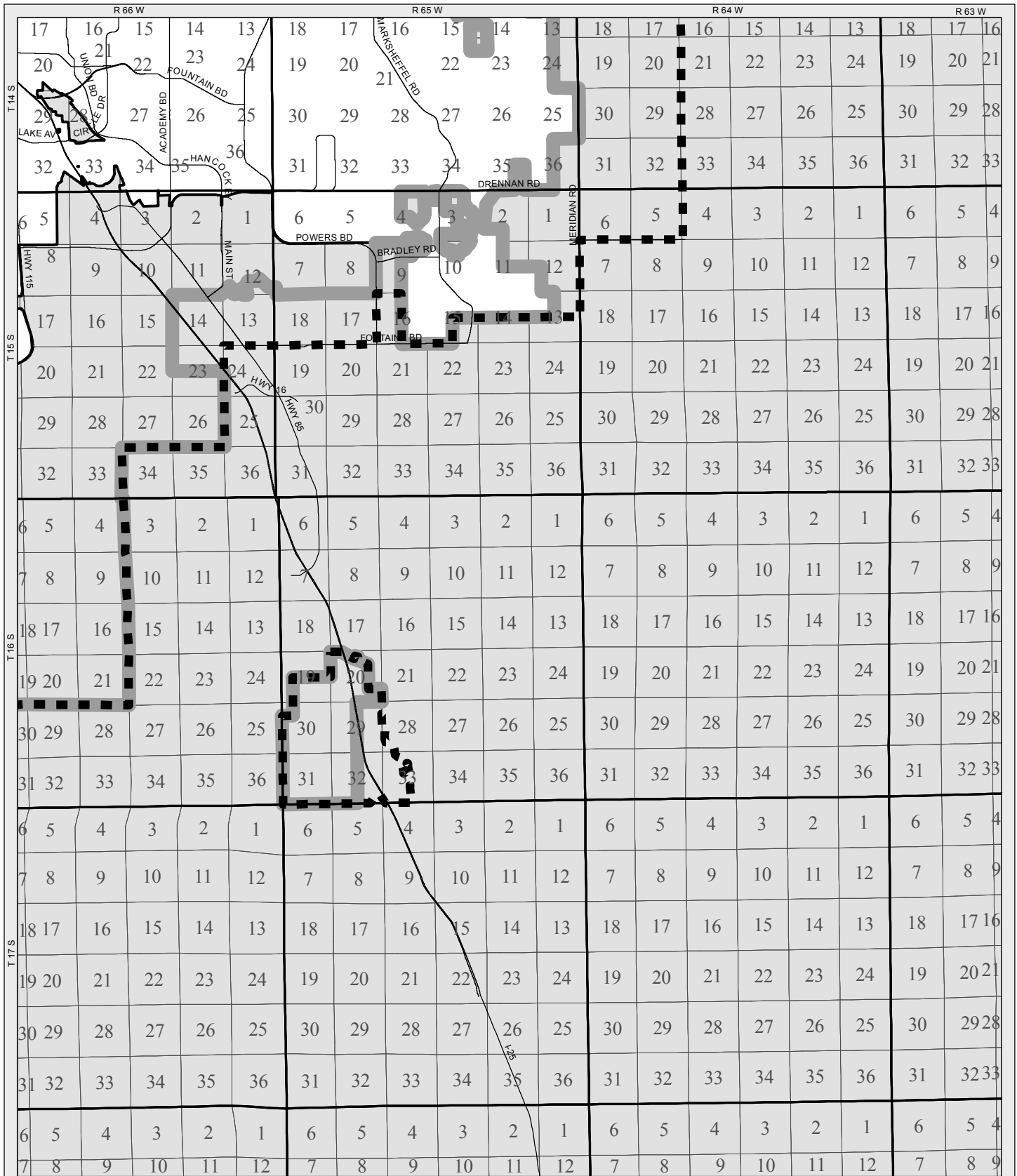



Colorado Springs Utilities
It's how we're all connected

Scale 1" = 14000'



Legend

-  Electric Service Area
-  Gas Service Area
-  Colorado Springs Boundary
-  Section Lines
-  Township/Range Lines

**Colorado Springs Utilities
Service Area Boundaries**

Page A-6

TABLE OF CONTENTS

Appendix B Utilities Addressing Plan, Utilities Design CAD File and Easements Policies and Procedures

Chapter Number	Title	Page Number
B.1.0	Introduction.....	B-2
B.2.0	Utilities Addressing Plan.....	B-2
B.2.1	Conditions Calling for a Utilities Addressing Plan.....	B-2
B.2.2	Purpose of the Utilities Addressing Plan.....	B-3
B.2.3	Utilities Addressing Plan Submittal.....	B-3
B.2.4	UAP Frequently Asked Questions.....	B-3
B.3.0	Utilities Design CAD File.....	B-3
B.3.1	Conditions Calling for a Utilities Design CAD File.....	B-4
B.3.2	Purpose of the Utilities Design CAD File.....	B-4
B.3.3	Utilities Design CAD File Submittal.....	B-4
B.3.4	UDCF Frequently Asked Questions.....	B-5
B.4.0	Easements.....	B-6
B.4.1	Conditions Calling for an Easement.....	B-6
B.4.2	Required Easement Elements.....	B-6
B.4.3	Easement Submittal Process.....	B-6
B.4.4	Easement Frequently Asked Questions.....	B-7
FORM 1	UAP Checklist.....	B-8
TABLE A	UDCF Feature List.....	B-9

UTILITIES ADDRESSING PLAN,
UTILITIES DESIGN CAD FILE AND EASEMENTS
Policies and Procedures Guide

B.1.0 INTRODUCTION

Interaction with Colorado Springs Utilities (UTILITIES) on any land development project requires supporting documentation. This information is unique to a given type of service (i.e. electric, gas, water or wastewater). There are two types of support data that are universal to all service extensions: the Utilities Addressing Plan (UAP) and the Utilities Design CAD File (UDCF). Depending upon the nature and timing of your project you may need to submit a UAP and/or a UDCF as part of the flow of information to UTILITIES in support of the design or review of your proposed utility infrastructure. It is best to be aware of these two items as well as potential easement requirements in advance of your first contact with UTILITIES regarding a given project. The following Sections describe each item in detail.

B.2.0 UTILITIES ADDRESSING PLAN

The UAP is a submittal that must be made, under certain circumstances, to UTILITIES prior to initiating a request for utility design review or service extension from SU. The content of the UAP is similar to that of a subdivision plat (see FORM 1 for the UAP checklist). In fact, a copy of the subdivision plat prepared per the City of Colorado Springs Code pertaining to Subdivision Platting will suffice as a UAP submittal. Advanced Geomatics (ADG) uses the UAP to obtain addressing from the Regional Building Department's (RBD) enumerator's office for the lots in the project. ADG converts lot geometry for the proposed project to the cadastral layers of the ADG database and create address pointers for the lots. The ADG cadastre, address data and SU's Customer Care and Billing (CCnB) system are synchronized using this information.

B.2.1 CONDITIONS CALLING FOR A UTILITIES ADDRESSING PLAN

A Utilities Addressing Plan is required to be submitted to UTILITIES anytime an application for the design of extensions of electric, gas, water or wastewater mains and/or service lines is made and any of the following conditions apply:

- The request for service applies to a parcel of land that does not have a recorded final subdivision plat and assigned addressing in place as of the date of the request.
- The request for service applies to a parcel of land which may have an existing recorded plat in place, but the existing parcel geometry will be modified as part of a land development process and the replat is not yet of record.
- The request for service applies to a parcel of land for which an approved UAP exists, but changes have been made (or are proposed) to the geometry of the development which substantially affects the lot or street configuration of the development.
- The proposed development activity will in any way change approved addressing on the site.

B.2.2 PURPOSE OF THE UTILITIES ADDRESSING PLAN

The UAP serves two critical purposes in the land development process. Information provided on the UAP allows ADG to create preliminary lot and street geometry in the UTILITIES Geographic Information Systems database. Approved addressing is then entered into the addressing database which in turn is tied to the UTILITIES CCnB system. With this in mind, consider the UAP as a “Preliminary” version of the final plat. The data elements to be shown are nearly identical to a final plat and in fact, an unrecorded copy of the final plat of the project is an acceptable UAP.

B.2.3 UTILITIES ADDRESSING PLAN SUBMITTAL

The UAP can be submitted in either hardcopy format or electronically. The UAP must be submitted at least five (5) working days prior to the need for SU’s action on a request for service. Requests for service may be submitted concurrently with the UAP but will not be acted upon until after the UAP has been processed.

A revised UAP must be submitted whenever boundary, right-of-way, lot or easement lines or dimensions are revised, or if addresses or street names are changed.

Digital submittal

Digital UAP submittals are the preferred method. Digital submittals may be performed online using the Digital Data Services web link (<https://www.csu.org/Pages/GISMapping.aspx>). When a submittal is made online, a receipt is emailed to the user. This receipt must accompany the request for utility service, as evidence that the UAP has been processed if the UAP is required (see above section for conditions requirement). A digital submission shall consist of an AutoCAD drawing (.dwg) file with a layout for each sheet (where there are multiple sheets to the plan) of the proposed project including all necessary model and paper space elements to enable ADG staff to print hard copies. For information or assistance in performing online UAP submittal, contact ADG staff at C_ADGSupport@csu.org or (719) 668-8340 or 668-8779.

B.2.4 UAP FREQUENTLY ASKED QUESTIONS

Do I need to have accurate and correct dimensioning for lots and streets centerlines on the UAP?

Although a preliminary version of the plat is acceptable for the UAP, fictitious, incomplete or erroneous plat geometry is not. UTILITIES require sufficient information on the UAP to be able to run coordinate geometry on the boundaries, the rights of way, tracts and each individual lot. Missing or erroneous data will only delay the UAP processing because ADG staff will refer the errors back to the submitter for correction before completing the UAP.

B.3.0 UTILITIES DESIGN CAD FILE

The Utilities Design CAD File (UDCF) is an AutoCAD (.dwg format) drawing file which contains specific point, line and text features related to the design and analysis of new utility lines in proposed land developments and public works projects. Defining the content and structure of the CAD data to be received allows ADG to position the UDCF file when necessary, enabling UTILITIES system designers to provide a more efficient design process for each land development customer. The primary use of the UDCF is to meet the requirements of the water, gas and electric system designers. It will contain electronic feature data (see TABLE A for a list of recommended features) needed to do CAD based

system design and analysis on new service system extensions. For residential projects, the UDCF contains most of the features on the water service plan. For commercial, multifamily and industrial projects, the UDCF will include the features from the site plan or site/utility plan. A secondary use of the feature data contained in the UDCF will be to update the planimetric base and utility mapping used by UTILITIES.

All dimensional data shall use AutoCAD drawing units of:

- Length: Decimal (Precision 0.000)
- Angle: Surveyor's units (Precision N 0d 00' 00" E)
- Insertion Scale: Unitless.

B.3.1 CONDITIONS CALLING FOR A UTILITIES DESIGN CAD FILE

A Utilities Design CAD File is to be submitted:

- For all projects that require utility system extensions or relocations.
- For all single-family residential projects that create new lots or rights of way through the subdivision platting process.
- For all mobile home parks, multifamily residential developments, commercial and industrial projects.

B.3.2 PURPOSE OF THE UTILITIES DESIGN CAD FILE

The Utilities Design CAD File will be used by the water system planners to model pressure zones, by the gas and electric system designers as a background environment to support their system extension design, and possibly by UTILITIES's Asset Management department to update planimetric base or utility mapping. The customer is responsible for ensuring that the project data supplied to UTILITIES is current through all project design phases. If UTILITIES does not have the most up to date version of project data, its construction schedule could be negatively impacted. The customer consents to UTILITIES use of the electronic data being used to update UTILITIES/ADG base mapping.

B.3.3 UTILITIES DESIGN CAD FILE SUBMITTAL

A Utilities Design CAD File (UDCF) is to be submitted to the Colorado Springs Utilities (UTILITIES) prior to or at the same time any application for water or wastewater plan review or service extension design is initiated. It may be submitted at the time of a UAP submittal or any time thereafter. A final submission of the UDCF is required and time of Development Services plan approval. The final UDCF must accurately match the approved plans. The file is to be submitted to UTILITIES's via an Internet application (<https://www.csu.org/Pages/GISMapping.aspx>). It is requested that the customer provide the UDCF file in the FIMS horizontal coordinate system. UTILITIES/ADG will process the file by registering it to the FIMS horizontal coordinate system when necessary and making it available to all UTILITIES departments.

The CAD file to be submitted shall be a .dwg format file containing all *applicable* feature elements listed in Table A in model space. The Utilities Design CAD File shall be complete. One and only one file is to be submitted. Any XREFs need to be bound to the parent file. Features shall be placed on separate layers. Processing can be expedited if the layer organization delineated in Table A is followed. Residential subdivision projects shall include pertinent elements checked under the **Residential** column

of **Table A**. All other development types (commercial, multifamily residential, industrial and mobile home parks, Municipal and State projects) shall require that the CAD file include pertinent feature types checked under the column titled **All Others**. Generally speaking, on residential projects, the UDCF will contain the same feature data as the water service plan and on commercial and multifamily projects the UDCF will contain the same feature data as the site plan or the site/utility plan.

B.3.4 UDCF FREQUENTLY ASKED QUESTIONS

What is the UDCF used for?

The UDCF is needed for efficient system modeling and design of new utility infrastructure. The UDCF is processed by ADG to position the model space features contained in the file onto the FIMS horizontal datum. The file structure is checked to ensure the file will be readable by all CAD desktops within UTILITIES and is then made available on a server that is accessible to all UTILITIES system designers.

The UDCF data may be used to maintain the FIMS planimetric database. Certain features will be verified and converted to keep the planimetric base mapping up to date. It is hoped that UTILITIES will realize long term cost savings for our ratepayers by reducing the number and frequency of aerial mapping projects needed to map areas of development activity.

I have several .dwg files that are not XREF'd for my project, how can I submit them?

Although we accept zipped files for large .dwg files we cannot accept multiple files zipped together, they must be merged into one .dwg file (using the X-REF/BIND command in AutoCAD). Do not use the re-submit option as a method to upload multiple files.

Does the UDCF have to conform to a certain layering standard?

No. Although Appendix A indicates the recommended layer structure, this is not a requirement. Processing the file can be made more efficient if the file conforms to the recommended layering structure, but it is not a requirement of the process.

Who will be responsible for assuring that the UDCF is accurate, complete and up to date?

Ultimately, the customer is responsible for the content of the file. ADG will perform a quick check ensure the file appears to be complete. If obvious inadequacies exist, UDS will contact the customer to remedy the situation. Missing or inaccurate data may affect the timing of design or construction schedules. The customer will be responsible for submitting an amended file should any of the projects feature details change after the time of the initial submittal but prior to completion of the use of the data by water, gas, and electric designers. The online application was designed to make iterative resubmission of data more convenient for the UTILITIES's customers. UTILITIES representatives will make every effort to remind the customer at each application stage to keep the file up to date.

What about projects that are not done using CAD?

It is recognized that there are still some small projects that may not be designed using CAD tools and there are still some design firms that do not employ CAD to accomplish project design. This submittal is not required if CAD data is not available. It should be recognized that plan review and new system design can be greatly expedited if a Utilities Design CAD File is supplied; otherwise UTILITIES system designers will have to spend time manually creating key planimetric features to complete their work. The whole point in acquiring the file is to make the design process for each department more efficient.

B.4.0 EASEMENTS

Development activity often requires an extension of UTILITIES’s infrastructure, which in turn may lead to the need for an easement or executive agreement. Across City property (not a Public Right – Of – Way), an Executive Agreement is required. On private property, Easements are required when infrastructure is placed outside of a public right-of-way. Easements are typically granted either by a Subdivision Plat or by a Permanent Easement Agreement. Easements granted by Subdivision Plat are governed by the City of Colorado Springs Code pertaining to Subdivisions, as modified by the Terms & Conditions recorded at Reception Number 212112548. Easements obtained through a Permanent Easement Agreement are controlled by the Utilities’ Standard Procedures for Easement Acquisition and Reference (SPEAR) process. The Spear Easements process now goes through the Construction & Development Hub. At this location users can select the “Development Process” link to see Utilities’ Development process and all the phases within. Under the Construction Phase, the user can select Easement Submittal link that will provide access to the Utilities Easement Procedures along with Easement Preparation Checklists. The user will also find a series of Permanent Easement Templates for different types of easements. This information will guide the user through the easement Submittal process where the required checklist can be submitted to Development Services for review.

B.4.1 CONDITIONS CALLING FOR AN EASEMENT

If utilities are installed outside of a public right-of-way or existing UTILITIES utility easement, then a UTILITIES utility easement must be granted. The need for an easement may be triggered by a neighboring development or even a UTILITIES initiated project that requires the installation of utilities across the property and not falling within a dedicated right-of-way or existing easement. These circumstances would require the recording of a Permanent Easement Agreement

B.4.2 REQUIRED EASEMENT ELEMENTS

SU’s Permanent Easement Agreement has a standard set of Terms & Conditions, and three (3) exhibits. Exhibit A is a description of the parcel burdened by the easement. This description could consist of a reference to a platted lot, a metes and bounds description or an existing reception number / book and page. Exhibit B is a description of the easement area. Exhibit C is a graphical representation of the easement area described in Exhibit B. UTILITIES require that Exhibit B be prepared, signed and sealed by a Colorado Professional Land Surveyor.

UTILITIES staff reviews the easement document for conformance to the design specification, and generally accepted surveying standard of care. During the review process comments may be referred back the Land Developer for review or revision. Upon acceptance by UTILITIES the easement is recorded at the Clerk & Records Office, and a recorded copy provided to the Land Developer.

B.4.3 EASEMENT SUBMITTAL PROCESS

Most easements dedicated to UTILITIES are initiated by the developer of the property in order to receive utility service. The need for a utility easement is identified during the Development Plan review process. The submittal process is explained on the UTILITIES website at the link given in 4.0 above.

Some of the key aspects are:

1. Always download the latest easement agreement forms from the UTILITIES website.

2. A licensed professional land surveyor must sign and certify that the exhibits prepared under their direct supervision, are accurate and correct to the best of their knowledge.
3. All owners and any Deed of Trust holders must sign the easement and ensure that their signatures are notarized.

B.4.4 EASEMENT FREQUENTLY ASKED QUESTIONS

How wide of an easement do I need to grant?

In general, a water or wastewater main requires a 30' easement width and a multi-utility easement is required to be 50' wide. Sometimes a wider easement is required based on characteristics of the line such as size, pressure, slope or depth of installation. Contact Development Services or refer to the appropriate standards to understand what the easement width might be for your utility installation project.

Can the utility be installed within an existing access easement?

Not typically. The Terms and Conditions of the actual easement agreement would need to be reviewed for language permitting the installation, maintenance and access to the infrastructure.

I need to dedicate an easement across multiple lots. What is the best way to do this?

If the multiple lots are owned by the same legal entity, the easement could be granted on a single easement. If the easement would include multiple owners, it is required that the easement be split into multiple sections so that each easement is granted by a single legal entity. The exception to this is for property held jointly for which a standard easement agreement was prepared.

What rights do I as the owner retain within the easement area?

Springs Utilities Permanent Easement Agreement is very specific on what rights are granted to the City of Colorado Springs and what rights are retained by the property owner. Please refer to the easement agreement, contact Development Services or seek legal counsel for answers to more specific questions.

FORM 1

UTILITIES Addressing Plan Check List

- 1 Name of the Utilities Addressing Plan
- 2 Name and address of the legal owner and/or manager of the project.
- 3 Name and address of the preparer of the Utilities Addressing Plan
- 4 Date of preparation
- 5 North arrow
- 6 Vicinity Map
- 7 Graphic scale
- 8 Delineate all lands to be conveyed or reserved for public use or reserved for the common use of all property owners in the proposed subdivision/project.
- 9 The dimensions of the exterior boundary of the proposed project, which must be the result of a boundary survey. All lines are to be annotated with a bearing and distance. All curved lines should be annotated with a minimum of three curve elements. Non-tangent curves should have a bearing reference (i.e., bearing to radius point or chord bearing).
- 10 The dimensions of all interior streets and lots. All lines are to be annotated with a bearing and distance. All curved lines should be annotated with a minimum of three curve elements. Non-tangent curve should have a bearing reference (i.e., bearing to radius point or chord bearing).
- 11 Lot and block numbers
- 12 Dimensions sufficient to clearly locate and define the extents of all easements to allow for the final design of the associated utilities. Side and rear lot easements may be described as text rather than graphical if a blanket statement is possible.
- 13 Names of the public or private streets or other public or private ways. Any private street name shall be clearly labeled "Private".
- 14 Area in square feet of each lot within the Utilities Addressing Plan.
- 15 Addressing is complete and legible (If Addressing is obtained from the Enumerator prior to UAP submittal. Note: This will not speed up the processing as UTILITIES will need to get verification from Enumerator that addressing is correct). If addressing has not been obtained prior to the UAP submittal, please indicate the location of addresses requested with "()".

NOTES:

- 1) Although not a requirement for the acceptance or approval of a UAP, in the instances of multi-family, commercial, or industrial developments where the plans for the development have progressed to the point of having final building locations and configurations, this plan may (at the discretion of the submitter) accompany the UAP submittal to assist the enumerator in assigning addresses to the project.
- 2) A final plat document prepared in accordance with City of Colorado Springs specifications will be acceptable as a UAP document.

Table A – UDCF Feature List

Recommended Feature Data	Residential	All Others	Recommended CAD Layer Name
Lot Lines	X	X	xx-lots-lin
Project Exterior Boundary Lines	X	X	xx-sub-bdy
Street Lines	X	X	xx-row-street
Easements	X	X	see list below
			xx-esmt-access
			xx-esmt-avig
			xx-esmt-drain
			xx-esmt-pub
			xx-esmt-scenic
			xx-esmt-trail
			xx-esmt-util
			xx-easmt-util-gas
			xx-easmt-util-elec
			xx-easmt-util-water
			xx-easmt-util-ww
			xx-esmt-util_drain
			xx-esmt-util_pub
			xx-esmt-util-misc
Building Footprints		X	xx-building-ftpnt
Water Lines	X	X	xx-water-line
Water Services	X	X	xx-water-serv
Water Valves		X	xx-water-valve
Fire Hydrants	X	X	xx-water-fh
Gas main lines (proposed)	X	X	pp-gas-line
Gas service lines (proposed)	X	X	pp-gas-stub
Electric lines (proposed)	X	X	pp-elec-line-ug (underground)
			pp-elec-line-ug (overhead)
Transformer Location		X	pp-elec-tr_pad
Elec sevice attachment points (proposed)		X	pp-elec-serv_att_pt
Secondary Electric		X	xx-electric-line-ug (overhead)
			xx-electric-line-ug (underground)
Sanitary Sewer Lines	X	X	xx-ww-line
Sanitary Sewer Manholes	X	X	xx-ww-mh
Sanitary Sewer Services	X	X	xx-ww-serv
Underdrains	X	X	xx-drain-udline
Storm Sewer Lines	X	X	xx-drain-line
Storm Sewer Inlets (Catch Basins)	X	X	xx-drain-catch
Curb Lines	X	X	xx-curb-back
			xx-curb-fl
			xx-curb-lip
Hard Surfaces (Paved Areas)		X	see list below
			xx-alley-pvd
			xx-drain-chan-ld
			xx-drain-cross
			xx-drive-pvd

Recommended Feature Data	Residential	All Others	Recommended CAD Layer Name
			xx-parking-pvd
			xx-sidewalk-ln
			xx-street-pvd
			xx-trail-rec
Private Lighting		X	xx-landscape-light
Private Signs		X	xx-sign-post
Grading / Contours		X	xx-cont-index
			xx-cont-int
Project Phase Lines		X	xx-devel-phase
Existing Adjacent Utilities (non Colorado Springs Utilities)		X	see list below
			xx-phone-serv
			xx-phone-line-oh (overhead)
			xx-phone-line-ug (underground)
			xx-phone-mh
			xx-phone-pole
			xx-phone-riser
			xx-phone-vault
			xx-pipeline-oh (overhead)
			xx-pipeline-ug (underground)
			xx-tower-loc
			xx-catv-line-oh (overhead)
			xx-catv-line-ug (underground)
			xx-catv-riser
			xx-fibop-line
			xx-fibop-box
Annotation			
Lot Dimensions	X	X	xx-lot-anno
Lot/ Block Numbers	X	X	xx-lots-anno
Addresses	X	X	xx-building-add

TABLE OF CONTENTS

APPENDIX C

Tables

Table Number	Title	Page Number
	Service Line Sizing Guide.....	C-2
1	Service Line Sizing, Pressure District with Maximum Allowable Operating Pressure Less Than 10 PSIG	C-3
2	Service Line Sizing, Pressure District with Maximum Allowable Operating Pressure Greater Than or Equal to 10 PSIG But Less Than 60 PSIG	C-4
3	Service Line Sizing, Pressure District with Maximum Allowable Operating Pressure Greater Than or Equal to 60 PSIG	C-5
4	Minimum Bending Radius for Polyethylene Pipe	C-6
5	Normal Fusion Heating/Cooling Times	C-7
6	Minimum Distance Between Fusions	C-7
7	Materials Approved for Use in Gas/Joint Service Line Construction	C-8
8	Clearance Matrix for Typical Colorado Springs Underground Utilities....	C-10
9	Joint Trench Inspection Appointment Scheduling & Cancellation Criteria	C-12
10	Joint Trench Inspection Checklist.....	C-13
11	Minimum and Maximum Cover for Natural Gas Lines.....	C-16

SERVICE LINE SIZING GUIDE

(Reference Tables 1-3)

Table 1	Service Line Sizing, PRESSURE DISTRICT WITH MAXIMUM ALLOWABLE OPERATING PRESSURE LESS THAN 10 PSIG
Table 2	Service Line Sizing, PRESSURE DISTRICT WITH MAXIMUM ALLOWABLE OPERATING PRESSURE GREATER THAN OR EQUAL TO 10 PSIG, <i>BUT</i> LESS THAN 60 PSIG
Table 3	Service Line Sizing, PRESSURE DISTRICT WITH MAXIMUM ALLOWABLE OPERATING PRESSURE GREATER THAN OR EQUAL TO 60 PSIG

REMINDER: Service lines that provide a total load **exceeding 1,000,000 BTU/HR** **MUST BE** sized by Colorado Springs Utilities Field Engineering

TOTAL CONNECTED LOAD = THE SUMMATION OF THE NAMEPLATE INPUT RATINGS FOR ALL GAS APPLIANCES THE SERVICE LINE IS TO SUPPLY. TYPICALLY REPORTED IN BTU/HR.

Service Line Length = The total length of the service line between the main and the riser.

Example Problem:

A residence has a 45,000 BTU/HR water heater and an 80,000 BTU/HR furnace. The distance from the main to the riser is 200 feet. The residence is located in a pressure district with a maximum allowable operating pressure of 15 psig. Find the required service line size.

Solution:

1. Look up the sizing table. You will need to use Table 2 (Service Line Sizing, Pressure District with Maximum Allowable Operating Pressure Greater Than or Equal to 10 PSIG, But Less Than 60 PSIG) for determining the correct service line size.
2. Add up the total connected load: $45,000 \text{ BTU/HR} + 80,000 \text{ BTU/HR} = 125,000 \text{ BTU/HR}$.
3. Note that the service line length at the residence is 200 feet long.
4. Look on Table 2 and find the intersection of the row containing the 125,000 BTU/HR total connected load and the column showing the 200 feet long service line. The intersection falls within shaded area "B". According to the legend, "B" = 3/4" IPS polyethylene.

TABLE 1

SERVICE LINE SIZING, PRESSURE DISTRICT WITH MAXIMUM ALLOWABLE OPERATING PRESSURE LESS THAN 10 PSIG

REMINDER: Service lines that provide a total load exceeding 1,000,000 BTU/HR must be sized by Colorado Springs Utilities Field Engineering

TOTAL CONNECTED LOAD (1000 BTU/HR)	SERVICE LINE LENGTH (FEET)															
	50	100	150	200	250	300	350	400	450	500	550	600	650	700	750	800
75	B	B	B	B	B	B	B	B	B	B	B	B	B	B	B	B
100	B	B	B	B	B	B	B	B	B	B	B	B	C	C	C	C
125	B	B	B	B	B	B	C	C	C	C	C	C	C	C	C	C
150	B	B	B	B	C	C	C	C	C	C	C	C	C	D	D	D
175	B	B	B	C	C	C	C	C	C	C	D	D	D	D	D	D
200	B	B	C	C	C	C	C	C	D	D	D	D	D	D	D	D
250	B	C	C	C	C	D	D	D	D	D	D	D	D	D	D	E
300	B	C	C	D	D	D	D	D	D	D	D	E	E	E	E	E
350	B	C	D	D	D	D	D	D	E	E	E	E	E	E	E	E
400	C	C	D	D	D	D	E	E	E	E	E	E	E	E	E	E
450	C	D	D	D	D	E	E	E	E	E	E	E	E	E	E	E
500	C	D	D	D	E	E	E	E	E	E	E	E	E	E	E	E
600	C	D	D	E	E	E	E	E	E	E	E	E	E	E	E	E
700	D	D	E	E	E	E	E	E	E	E	E	E	E	E	E	
800	D	D	E	E	E	E	E	E	E	E	E	E				
900	D	E	E	E	E	E	E	E	E	E			CONTACT FIELD ENGINEERING			
1000	D	E	E	E	E	E	E	E	E							

NOTE: All commercial and industrial lines shall be 1-1/4” IPS minimum.

LEGEND:

- B** = 3/4” IPS Polyethylene Service Line
- C** = 1” IPS Polyethylene Service Line
- D** = 1-1/4” IPS Polyethylene Service Line
- E** = 2” IPS Polyethylene Service Line

TABLE 2

SERVICE LINE SIZING, PRESSURE DISTRICT WITH MAXIMUM ALLOWABLE OPERATING PRESSURE GREATER THAN OR EQUAL TO 10 PSIG BUT LESS THAN 60 PSIG

REMINDER: Service lines that provide a total load **exceeding 1,000,000 BTU/HR must be sized by Colorado Springs Utilities Field Engineering**

TOTAL CONNECTED LOAD (1000 BTU/HR)	SERVICE LINE LENGTH (FEET)															
	50	100	150	200	250	300	350	400	450	500	550	600	650	700	750	800
75	B	B	B	B	B	B	B	B	B	B	B	B	B	B	B	B
100	B	B	B	B	B	B	B	B	B	B	B	B	B	B	B	B
125	B	B	B	B	B	B	B	B	B	B	B	B	B	B	B	B
150	B	B	B	B	B	B	B	B	B	B	B	B	B	B	B	B
175	B	B	B	B	B	B	B	B	B	B	B	B	B	B	B	B
200	B	B	B	B	B	B	B	B	B	B	B	B	B	B	B	B
250	B	B	B	B	B	B	B	B	B	B	B	B	B	B	B	B
300	B	B	B	B	B	B	B	B	B	B	B	B	B	B	B	B
350	B	B	B	B	B	B	B	B	B	B	B	B	B	B	B	B
400	B	B	B	B	B	B	B	B	B	B	B	B	B	B	B	C
450	B	B	B	B	B	B	B	B	B	B	B	B	C	C	C	C
500	B	B	B	B	B	B	B	B	B	B	C	C	C	C	C	C
600	B	B	B	B	B	B	B	C	C	C	C	C	C	C	C	C
700	B	B	B	B	B	C	C	C	C	C	C	C	C	C	C	C
800	B	B	B	B	C	C	C	C	C	C	C	C	C	D	D	D
900	B	B	B	C	C	C	C	C	C	C	C	D	D	D	D	D
1000	B	B	B	C	C	C	C	C	C	D	D	D	D	D	D	D

NOTE: All commercial and industrial lines shall be 1-1/4" IPS minimum.

LEGEND:

- B** = 3/4" IPS Polyethylene Service Line
- C** = 1" IPS Polyethylene Service Line
- D** = 1-1/4" IPS Polyethylene Service Line
- E** = 2" IPS Polyethylene Service Line

TABLE 3

SERVICE LINE SIZING, PRESSURE DISTRICT WITH MAXIMUM ALLOWABLE OPERATING PRESSURE GREATER THAN OR EQUAL TO 60 PSIG

REMINDER: Service lines that provide a total load exceeding 1,000,000 BTU/HR must be sized by Colorado Springs Utilities Field Engineering

TOTAL CONNECTED LOAD (1000 BTU/HR)	SERVICE LINE LENGTH (FEET)															
	50	100	150	200	250	300	350	400	450	500	550	600	650	700	750	800
75	B	B	B	B	B	B	B	B	B	B	B	B	B	B	B	B
100	B	B	B	B	B	B	B	B	B	B	B	B	B	B	B	B
125	B	B	B	B	B	B	B	B	B	B	B	B	B	B	B	B
150	B	B	B	B	B	B	B	B	B	B	B	B	B	B	B	B
175	B	B	B	B	B	B	B	B	B	B	B	B	B	B	B	B
200	B	B	B	B	B	B	B	B	B	B	B	B	B	B	B	B
250	B	B	B	B	B	B	B	B	B	B	B	B	B	B	B	B
300	B	B	B	B	B	B	B	B	B	B	B	B	B	B	B	B
350	B	B	B	B	B	B	B	B	B	B	B	B	B	B	B	B
400	B	B	B	B	B	B	B	B	B	B	B	B	B	B	B	B
450	B	B	B	B	B	B	B	B	B	B	B	B	B	B	B	B
500	B	B	B	B	B	B	B	B	B	B	B	B	B	C	C	C
600	B	B	B	B	B	B	B	B	B	B	C	C	C	C	C	C
700	B	B	B	B	B	B	B	C	C	C	C	C	C	C	C	C
800	B	B	B	B	B	B	C	C	C	C	C	C	C	C	C	C
900	B	B	B	B	C	C	C	C	C	C	C	C	C	C	D	D
1000	B	B	B	B	C	C	C	C	C	C	C	C	D	D	D	D

NOTE: All commercial and industrial service lines shall be 1-1/4" IPS minimum.

LEGEND:

- B** = 3/4" IPS Polyethylene Service Line
- C** = 1" IPS Polyethylene Service Line
- D** = 1-1/4" IPS Polyethylene Service Line
- E** = 2" IPS Polyethylene Service Line

TABLE 4

MINIMUM BENDING RADIUS FOR POLYETHYLENE PIPE

NOMINAL PIPE DIAMETER	OUTSIDE DIAMETER	MINIMUM DISTANCE TO NEAREST FUSION (5xOD)	MINIMUM BENDING RADIUS (A)	
			(C) NO FUSIONS 25xOD	(D) WITH FUSION JOINT 100xOD
3/4", SDR 11	1.050"	6"	27"	105"/8'9"
1", SDR 11	1.315"	7"	33"	132"/11'
1-1/4", SDR 10	1.660"	9"	42"	166"/13'10"
2", SDR 11	2.375"	12"	60"	238"/19'10"

A smaller bend radius results when the curvature of the pipeline is tightened. Plastic pipe cannot be installed with a bend radius that is less than the minimum bend radius specified by the manufacturer for the diameter of the pipe being installed.

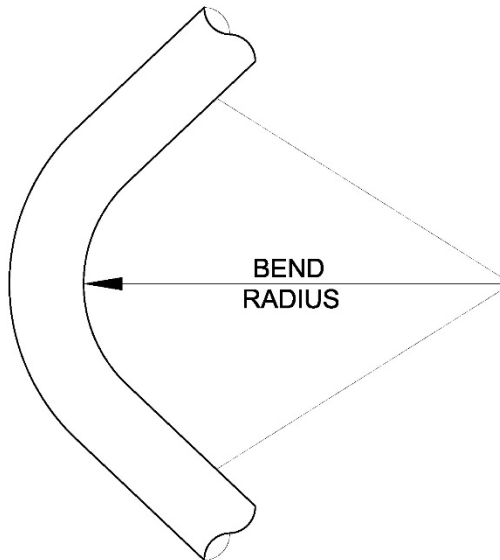

- (A) The minimum bend radius is the smallest radius to which the pipe can safely be curved.
- (B) The minimum distance to the nearest fusion shall mean the distance measured along the pipe from the nearest socket fusion to the point at which the bend radius begins.
- (C) No fusions are allowed within the bend.
- (D) Fittings are rigid compared to the pipe, therefore, the minimum bend radius is increased to 100 times the pipe's outside diameter (OD) when a fitting is present in the bend. The bend radius should be limited to 100 x OD for a distance of about 5 times the pipe diameter on either side of the fitting location. LUSIs are not permitted to install fittings within the bend.

TABLE 5

NORMAL FUSION HEATING/COOLING TIMES

See Appendix F for the Colorado Springs Utilities Plastic Joining Procedures (socket portion only)

TABLE 6

MINIMUM DISTANCE BETWEEN FUSIONS

PE PIPE SIZE (IPS)	MINIMUM PIPE LENGTH (INCHES)
3/4"	12
1"	12
1-1/4"	15
2"	15

TABLE 7
MATERIALS APPROVED FOR USE IN GAS/JOINT SERVICE
LINE CONSTRUCTION

Item Description	Designation	Approved Manufacturer
Anodes	1 pound, bare, magnesium alloy	Galvotec Alloys Inc. Farwest Corrosion Control Corrpro Co. Anode Systems
1Pipe/Socket Fittings	PE 2708, ASTM D2513 < 3 yrs. Old 3/4", 1", 2" SDR 11 1-1/4" SDR 10	Performance Pipe JM Eagle Duraline (pipe only) Pipeline Plastics (pipe only)
Service Risers	Polyethylene Insert, Anodeless	
	PE Size	THREADS
	1" IPS SDR 11	1" NPT
	1-1/4" IPS SDR 10	1-1/4" NPT
	3/4" IPS SDR 11	1" NPT
	2" IPS SDR 11	2" NPT
	3/4" IPS SDR 11 Vertical Riser (1)	(1) Only with QC Inspector Supervisor approval
Service Riser Bracket	T-41 (1-1/4" diameter pipe, adjustable 6"-10")	Energy Control Systems, Inc.
Tape	Split Bolts	3M Scotch 130C Linerless Rubber Splicing Tape 3M Scotch 33, 3/4" Tape
	Wrap- Primerless Tapecoat, M50RCG (2", 4" & 6") Wrap – Gray Pipe Wrap Tapecoat, H35 UV Resistant (2") Scotchrap #50 (2")	The Tapecoat Company 3M
Thermite Weld Cartridge	15 Gram Charge	CadWeld
Copper Sleeve	For Tracer Wire	Continental A-200
Wire Connector	Direct Burial Split Bolt	Burndy Mechanical or Equiv.
Tracer Wire	Tracer wire, #12 high strength, soft-drawn CCS (copper clad steel), HDPE/ HMWPE yellow insulation, 30 mils, 30 VAC (wire to be labeled minimum interval of every two feet with "Gas" (preferred), Manufacturers name (or manufacturer's code), 12 AWG, CCS TRACER WIRE, 30V, 30M HDPE all other labeling will be rejected)	Kris-Tech Wire Company Copperhead Industries, LLC Proline Agave Wire, Ltd. (Note that Lyall risers, a division of Continental, use Agave Wire but label it as Continental)

Item Description	Designation	Approved Manufacturer
Gas Caution Tape (optional)	Yellow, Caution, Buried Gas Line Tape, min of 3 inches wide, 4 mil thick (non-detectable)	Brady
Padding (Bedding Sand)	Fine Material able to pass a #40 sieve and retained on a #200 sieve.	Daniels Sand, Cone Sand (multiple suppliers sell material from approved manufacturer)
4/0 AWG AL with 2/0 AWG AL Neutral Service Wire	600V UD “SureSeal” or “SuperSeal” Self-repairing wire types only	Southwire (SureSeal): <ul style="list-style-type: none"> • Wesco- Utility, Denver • Western United Electric Supply Pirelli/ Prysmian (SuperSeal): <ul style="list-style-type: none"> • Wesco- Utility, Denver • Utility Products Supply
350 MCM AL with 4/0 AWG AL Neutral	Abuse-Resistant type only	Southwire Pirelli (Prysmian) Alcan General Cable (BICC)
2” SCH 40 PVC	Electrical Rated (grey only)	All manufacturers including: Prime Cantex Heritage
3” & 4” DB120 or SCH 40 PVC	Electrical Rated (grey only)	All manufacturers including: Prime Cantex Heritage

TABLE 8

**CLEARANCE MATRIX FOR TYPICAL
COLORADO SPRINGS UNDERGROUND UTILITIES
(Separate Trenches)**

**TYPICAL PARALLEL/HORIZONTAL CLEARANCE MATRIX FOR
COLORADO SPRINGS UNDERGROUND UTILITIES**

(all dimensions in feet) All separations shown are the clear horizontal distance between two objects measured surface to surface

Colorado Springs Utilities (Underground)	Potable Water	Non-Potable Water	Waste-water	Storm Sewer	Gas mains 150 psig (MAOP)	Gas main	Gas Service	Electric Primary up to 34.5kV	Electric Secondary (0-480 Volt)	Telecom / Fiber
Potable Water	X	10	10	10 ^c	10	6	3	10 ^d	3	5
Non-Potable Water	10	X	10	10	10	6	3	10	3	5
Wastewater	10	10	X	10 ^c	10	6	3	10 ^d	3	5
Storm Sewer	10 ^c	10	10 ^c	X	10	6	3	10	3	5
Gas mains 150 psig (MAOP)	10	10	10	10	X	6	6	10	10	10
Gas main	6	6	6	6	6	X	3	6	3	5 ^e
Gas Service	3	3	3	3	6	3	X	3	3	3
Electric Primary up to 34.5kV	10 ^d	10	10 ^d	10	10	6	3	X	3	5 ^e
Electric Secondary (0-480 Volt)	3	3	3	3	10	3	3	3	X	5 ^e
Telecom / Fiber	5	5	5	5	10	5 ^e	3	5 ^e	5 ^e	X

**TYPICAL CROSSINGS/VERTICAL CLEARANCE MATRIX FOR
COLORADO SPRINGS UNDERGROUND UTILITIES:**

(all dimensions in feet) All separations shown are the clear vertical distance between two objects measured surface to surface

Colorado Springs Utilities (Underground):	Potable Water	Non-Potable Water	Waste-water	Storm Sewer	Gas mains 150 psig (MAOP)	Gas main	Gas Service	Electric Primary up to 34.5kV	Electric Secondary (0-480 Volt)	Telecom / Fiber
Potable Water	X	1.5 ^a	1.5 ^a	1.5 ^a	5	1	1	1	1	1
Non-Potable Water	1.5 ^a	X	1.5 ^a	1.5 ^a	5	1	1	1	1	1
Wastewater	1.5 ^a	1.5 ^a	X	1.5	5	1	1	1	1	1
Storm Sewer	1.5 ^a	1.5 ^a	1.5 ^a	X	5	1	1	1	1	1
Gas mains 150 psig (MAOP)	5	5	5	5	X		5	5	5	5
Gas main	1	1	1	1		X	1	1/5 ^b	1	1
Gas Service	1	1	1	1	5	1	X	1	1	1
Electric Primary up to 34.5kV	1	1	1	1	5	1/5 ^b	1	X	0	1
Electric Secondary (0-480 Volt)	1	1	1	1	5	1	1	0	X	1
Telecom / Fiber	1	1	1	1	5	1	1	1	1	X

NOTES:

1. If compliance with these separation requirements, or those set forth in the Clearance Matrix cannot be met they will be addressed on a case-by-case basis following variance procedures described in the applicable Line Extension and Service Standards book. This includes areas of redevelopment within alleys. Colorado Springs Utilities subject matter experts for the utility being impacted will make the determination regarding clearances.
2. These clearance matrix table dimensions are for separate trenches. Joint trench between Electric, Gas, and Colorado Springs Utilities Telecom/Fiber requires a 1' radial separation.
3. See the Gas Line Extension and Service Standards, 2.02c for certain exceptions, including tree separation requirements.
4. See Water & Wastewater Line Extension and Service Standards, latest edition.
5. Clearance to other Colorado Springs Utilities infrastructure (telecommunication, fiber optics, etc.) or high voltage underground transmission cables shall be determined on a case-by-case basis by Field Engineering.
6. Storm Sewer clearances must be verified by City Engineering.
7. Larger clearances than shown may be required – clearances must meet all requirements set forth in all four of the Colorado Springs Utilities Line Extension and Service Standards, Colorado Springs City Codes, NEC, and NESC, latest editions.
8. Additional support structures may be required at crossings.
9. For separation from trees to gas and electric lines, see GLESS 2.02c and ELESS 4.02c1.
10. See City of Colorado Springs Standard Drawings #1 “Street Cross Sections” and Drawings #2 “Street Sections Plan View” at the following web address link: <https://coloradosprings.gov/public-works/page/standard-drawings>

^a These utilities require a sleeve when crossing under another utility.

^b 1' separation from electric primary to plastic pipe gas main and 3' separation from electric primary to metallic gas main.

^c Exception: Minimum 5' separation if meets the means of secondary containment listed in the Water Line Extension and Service Standards Book 2.6.G.2 Separation Criteria and Wastewater Line Extension and Service Standards Book 2.5.D.2 Separation Criteria.

^d Exception: Minimum 6'-10" clearance from Electric Primary to Potable Water and Wastewater.

^e Exception: In scenarios where the gas main and electric primary or secondary is behind the curb and either in the tree lawn or under sidewalk, 3 feet of horizontal separation between telecom/fiber and gas mains, electric primary or electric secondary may be permitted. The exception may be allowed when the following requirements are met: 1) potholing and exposing the pipe every 50 feet must occur when directional drilling is within 5 feet of the gas or electric pipe; 2) potholing and exposing the pipe every 25 feet is required when pneumatic missiles/moles are used within 5 feet of the gas or electric pipe; 3) for bores less than 50 feet and within 5 feet of the gas or electric pipe (regardless of trenchless technology used), a minimum of one pothole is required; 4) potholing and exposing the gas or electric pipe where points of typical deviation may occur (e.g., hydrants, transformers, etc.) and 5) compliance with all State and local excavation, boring, and damage prevention rules and regulations. Additional excavation requirements are listed in the GLESS Section 1.03. All other scenarios must comply with clearance requirements in Table 8

TABLE 9

**JOINT TRENCH INSPECTION APPOINTMENT
SCHEDULING & CANCELLATION CRITERIA**

3 weeks to 4 business days prior to scheduled appointment date	3 business days prior to scheduled appointment date	2 business days prior to scheduled appointment date	1 business day prior to scheduled appointment date	Scheduled appointment date
Call any business day between 7:30 am and 2pm to schedule an appointment	Last day to call for appointment (between 7:30am and 2pm)			
Cancel anytime No fee charged	Cancel anytime and provide an alternate address No fee charged	Cancel anytime = incur Step 2 fee (25% of return trip fee)	Cancel anytime = incur Step 3 fee (50% of return trip fee)	Cancel anytime = incur Full return trip fee charged
	Cancel before 11:00 a.m., no alternate address = incur Step 1 fee (Cancellation fee - 10% of return trip fee)			
	Cancel after 11:00 a.m., no alternate address = incur Step 2 fee (25% of return trip fee)			

NOTES:

1. See 4.04c for Inclement Weather and Show Up Time explanation.
2. Once a licensed utility service installer schedules an address for a Joint Trench Service Line, Gas Only Service Line and/or an Electric Only Service Line Inspection and Tie-In appointment, the licensed utility service installer will only be allowed to move and/or reschedule that address appointment one time. At that point, it must be completed on the scheduled date and time or the appointment will “Fail” and incur a return trip fee.

TABLE 10

JOINT TRENCH INSPECTION CHECKLIST

Joint Service Inspection Checklist		
Number	Inspection Area	Item
1	Non Technical	<ul style="list-style-type: none">• Installer is a “no-show”. Not at job site within 15 minutes of scheduled appointment time.
2		<ul style="list-style-type: none">• Service not ready for inspection within 15 minutes of scheduled appointment time.
3		<ul style="list-style-type: none">• No visible address at inspection location.
4		<ul style="list-style-type: none">• Service location not marked on foundation.
5		<ul style="list-style-type: none">• Installer does not have valid Utility Installer license on person.
6		<ul style="list-style-type: none">• Installer not licensed.
7		<ul style="list-style-type: none">• Installer’s license suspended.
8		<ul style="list-style-type: none">• Installer’s license revoked.
9	Trench	<ul style="list-style-type: none">• No trench.
10		<ul style="list-style-type: none">• Trench obstructed.
11		<ul style="list-style-type: none">• Trench caved in.
12		<ul style="list-style-type: none">• Trench not proper width.
13		<ul style="list-style-type: none">• Trench not proper depth.
14		<ul style="list-style-type: none">• Improper separation between trench and other utilities and/or structures.
15		<ul style="list-style-type: none">• Improper clearance between spoil pile and trench.
16		<ul style="list-style-type: none">• Required shoring and/or sloping not present for trenches 4’ or deeper.
17	Bell Hole	<ul style="list-style-type: none">• No bell hole.
18		<ul style="list-style-type: none">• Improper bell hole size.
19		<ul style="list-style-type: none">• Bottom of bell hole not level.
20		<ul style="list-style-type: none">• Required shoring and/or sloping not present at bell hole.
21		<ul style="list-style-type: none">• Bell hole not proper depth below polyethylene or steel gas stub.
22		<ul style="list-style-type: none">• Improper clearance between spoil pile and bell hole.
23	Padding	<ul style="list-style-type: none">• No padding.
24		<ul style="list-style-type: none">• Unapproved padding material.
25		<ul style="list-style-type: none">• Improper padding depth.
26	Backfill	<ul style="list-style-type: none">• Backfill contains foreign material.
27		<ul style="list-style-type: none">• Service not covered with at least 12” of padding / backfill.
28	Gas Pipe	<ul style="list-style-type: none">• No gas pipe.
29		<ul style="list-style-type: none">• Unapproved pipe material.
30		<ul style="list-style-type: none">• Gas service line not sized for BTU load as specified.
31		<ul style="list-style-type: none">• Labels or identification on pipe/fitting not clear and visible.

Joint Service Inspection Checklist		
Number	Inspection Area	Item
32		<ul style="list-style-type: none"> • Damage to pipe wall is greater than 10% of wall thickness.
33		<ul style="list-style-type: none"> • Kink in polyethylene pipe.
34		<ul style="list-style-type: none"> • Improper snaking of pipe in trench.
35		<ul style="list-style-type: none"> • Improper placement of gas pipe in a joint service trench.
36		<ul style="list-style-type: none"> • Improper separation between gas service and electric conductor.
37		<ul style="list-style-type: none"> • Improper separation between pipe and other utilities or structures.
38		<ul style="list-style-type: none"> • Polyethylene pipe is out of date.
39		<ul style="list-style-type: none"> • Gas service line installed at property that does not have a main and stub.
40		<ul style="list-style-type: none"> • Polyethylene pipe not extended to stub as per specifications.
41		<ul style="list-style-type: none"> • Stub not exposed for fusion as per spec.
42		<ul style="list-style-type: none"> • Inadequate amount of stub exposed behind squeeze mark, damage, etc.
43	Fusions	<ul style="list-style-type: none"> • Improper fusion.
44		<ul style="list-style-type: none"> • Unapproved connection.
45	Tracer Wire	<ul style="list-style-type: none"> • No tracer wire.
46		<ul style="list-style-type: none"> • Unapproved tracer wire.
47		<ul style="list-style-type: none"> • Improper gauge of tracer wire.
48		<ul style="list-style-type: none"> • Tracer wire not taped properly or adequately.
49		<ul style="list-style-type: none"> • Tracer wire not secured properly to riser.
50		<ul style="list-style-type: none"> • Tracer wire spliced at location other than tie-in point.
51		<ul style="list-style-type: none"> • Tracer wire not full length of service.
52		<ul style="list-style-type: none"> • Coating damage to wire.
53		<ul style="list-style-type: none"> • Unapproved tracer wire splice.
54		<ul style="list-style-type: none"> • Split bolt connection not wrapped properly.
55		<ul style="list-style-type: none"> • Tracer wire wrapped around gas service.
56	Pressure Test	<ul style="list-style-type: none"> • No gauge installed.
57		<ul style="list-style-type: none"> • Over-pressurization of line.
58		<ul style="list-style-type: none"> • Under-pressurized line.
59		<ul style="list-style-type: none"> • Falsifying air pressure test.
60	Riser Bracket	<ul style="list-style-type: none"> • No riser bracket.
61		<ul style="list-style-type: none"> • Unapproved riser bracket.
62		<ul style="list-style-type: none"> • Unapproved attachment method (riser bracket to foundation).
63		<ul style="list-style-type: none"> • Riser bracket not straight and level.
64		<ul style="list-style-type: none"> • Riser bracket not securely attached to foundation.

Joint Service Inspection Checklist		
Number	Inspection Area	Item
65	Riser	<ul style="list-style-type: none"> • No riser.
66		<ul style="list-style-type: none"> • Unapproved riser.
67		<ul style="list-style-type: none"> • Riser not straight and level.
68		<ul style="list-style-type: none"> • Riser not at specified height.
69		<ul style="list-style-type: none"> • Distance between riser and openings into building not per spec.
70		<ul style="list-style-type: none"> • Improper riser clearance from foundation.
71		<ul style="list-style-type: none"> • Riser unable to be used.
72	Electric Conductor.	<ul style="list-style-type: none"> • No electric conductor.
73		<ul style="list-style-type: none"> • Unapproved electric conductor.
74		<ul style="list-style-type: none"> • Electric conductor not adequately sized for load.
75		<ul style="list-style-type: none"> • Electric conductor damaged.
76		<ul style="list-style-type: none"> • Electric conductor too short.
77		<ul style="list-style-type: none"> • Improper separation between electric conductor and gas service.
78		<ul style="list-style-type: none"> • Wrong size of electric cable; cable must match what is stubbed into the lot (size and number), but the wire must be no smaller than 4/0.
79		<ul style="list-style-type: none"> • Splice present in service line run.
80	Conduit	<ul style="list-style-type: none"> • Required conduit not installed.
81		<ul style="list-style-type: none"> • Conduit too short.
82		<ul style="list-style-type: none"> • Conduit not proper size.
83		<ul style="list-style-type: none"> • Conduit not proper type.
84		<ul style="list-style-type: none"> • Pull string not installed through conduit.
85		<ul style="list-style-type: none"> • Pull string not proper strength.

TABLE 11

MINIMUM & MAXIMUM COVER FOR NATURAL GAS LINES

CFR192.327 requires a minimum cover of 24 inches for natural gas lines. Colorado Springs Utilities requires a minimum cover to protect our facilities from anticipated external loads, and requires a maximum cover for reasonable access to these facilities for future maintenance. Colorado Springs Utilities Gas Planning & Design may specify when more/less cover is needed according to DOT code or operations and maintenance requirements.

NATURAL GAS LINE TYPE	MINIMUM COVER	MAXIMUM COVER
Gas Service Line	24	48
Gas Main with Pressure \leq 76 psig	30	48
Gas Main with Pressure $>$ 76 psig (High-Pressure Distribution System)	48	72

TABLE OF CONTENTS

APPENDIX D

Figures

Figure Number	Title	Page Number
1	Colorado Springs Utilities Owned Trench Diagrams	D-2
2	Riser Venting Through Asphalt & Concrete	D-4
3	Mobile Homes	D-4
4	Utility Lot Layout	D-5
5	Service Riser Details	D-7
6	Below Ground Multiple Meter Manifold.....	D-9
7	Above Ground Multiple Meter Manifold Fuel Line/Riser Configuration Residential Only (No Commercial).....	D-10
8	Typical Meter Sets	D-11
9	Meter Loop Location & Clearances.....	D-15
10	Meter Protection	D-17
11	Field Wrapping	D-18
12	Mercury Corrector & Communication Modem.....	D-19
13	Pulse-Initiating Device to Monitor Gas Usage.....	D-20
14	Required Air Pressure Test Gauge & Blow Down Assembly.....	D-21
15	Bollard Post Installations.....	D-22
16	Joint Trench Front Lot Layout.....	D-23

FIGURE 1
COLORADO SPRINGS UTILITIES OWNED TRENCH DIAGRAMS

FIGURE 1A
GAS ONLY SERVICE TRENCH

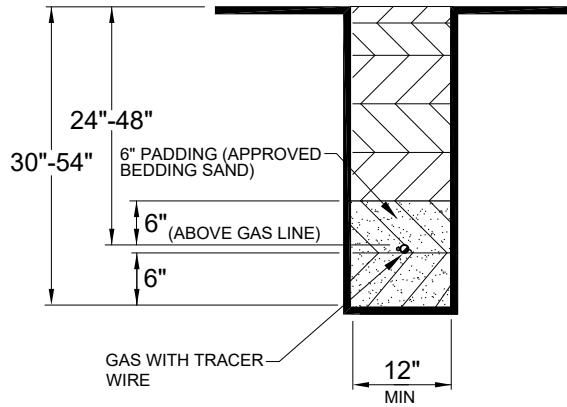

NOTE:
 No other utility or utility conduit is to be installed in a gas only trench. Gas only trenches shall be backfilled completely before the tie-in and inspection personnel leaves the jobsite address.

FIGURE 1B
RESIDENTIAL JOINT SERVICES TRENCH
(WITH HORIZONTAL SEPARATION)

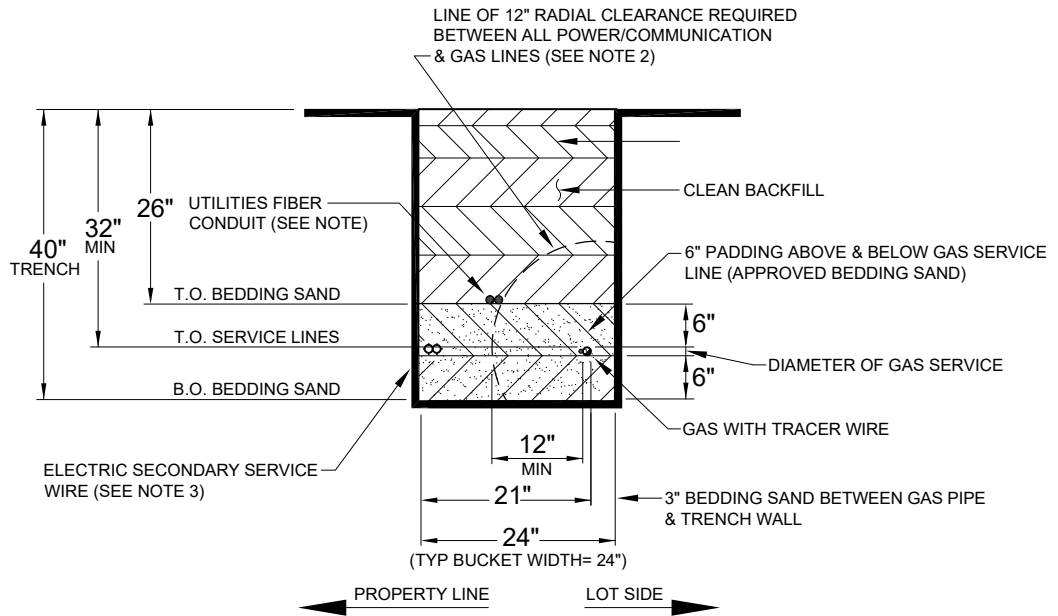
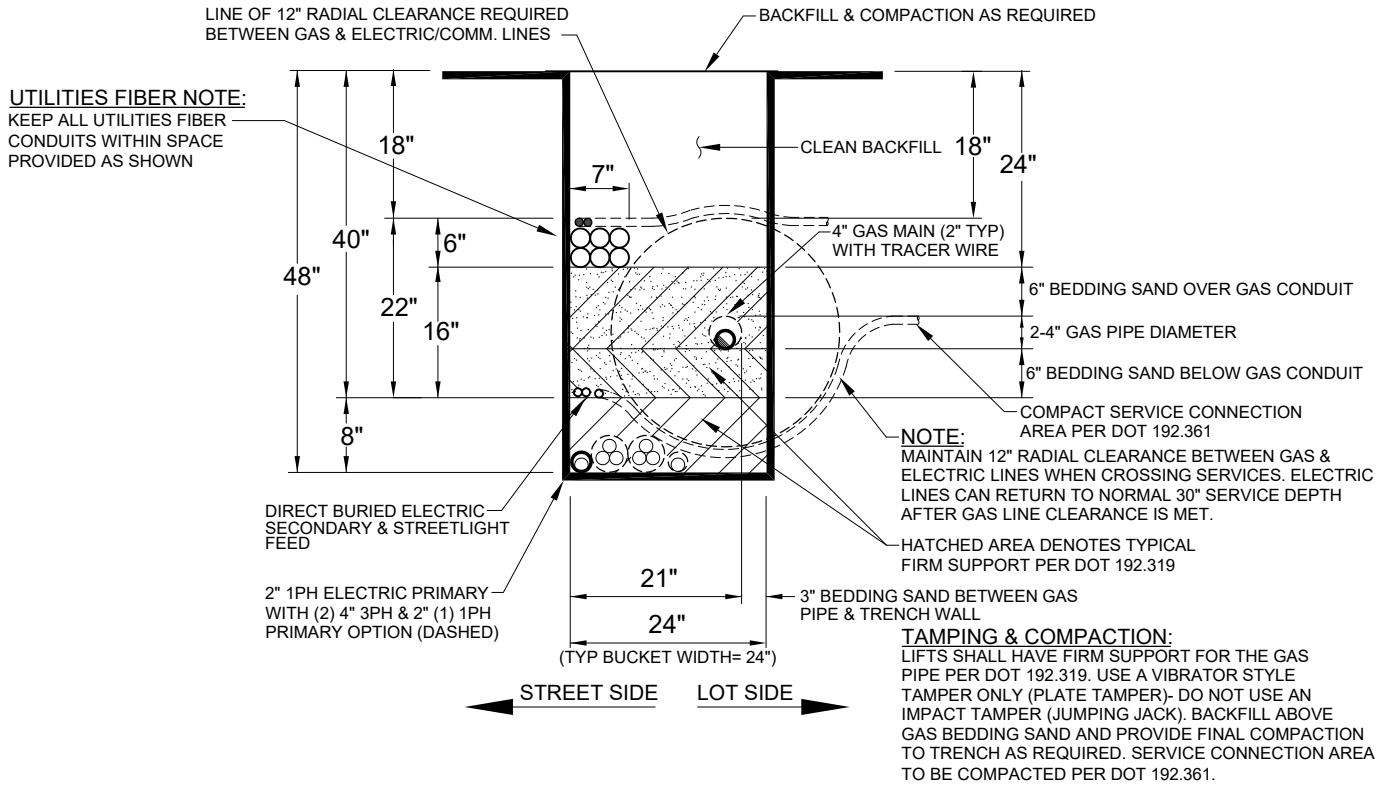

FIGURE 1
COLORADO SPRINGS UTILITIES OWNED TRENCH DIAGRAMS

FIGURE 1C
RESIDENTIAL MAIN JOINT TRENCH
(WITH HORIZONTAL SEPARATION)



NOTES:

- Licensed Utility Service Installer (LUSI) is responsible for sand padding 6" around the gas service line with 12" of spoil on top of the sand, before the tie-in and inspection personnel leaves the jobsite address.
- Maintain 12" minimum separation between Utilities' Fiber, Colorado Springs Utilities electric & gas lines as required by Colorado Springs Utilities policy.
- If electric and gas service lines ever need to cross each other, maintain 12" vertical separation between the crossing lines, and maintain 6" bedding sand above and below gas service line.
- Residential joint trenching shall only be allowed when in both the Colorado Springs Utilities electric and gas service territory.
- Commercial service installations are not to be joint trenched unless with approval of Colorado Springs Utilities.
- Gas only projects are required to be in the roadway and not behind curb.

FIGURE 2
RISER VENTING THROUGH ASPHALT & CONCRETE

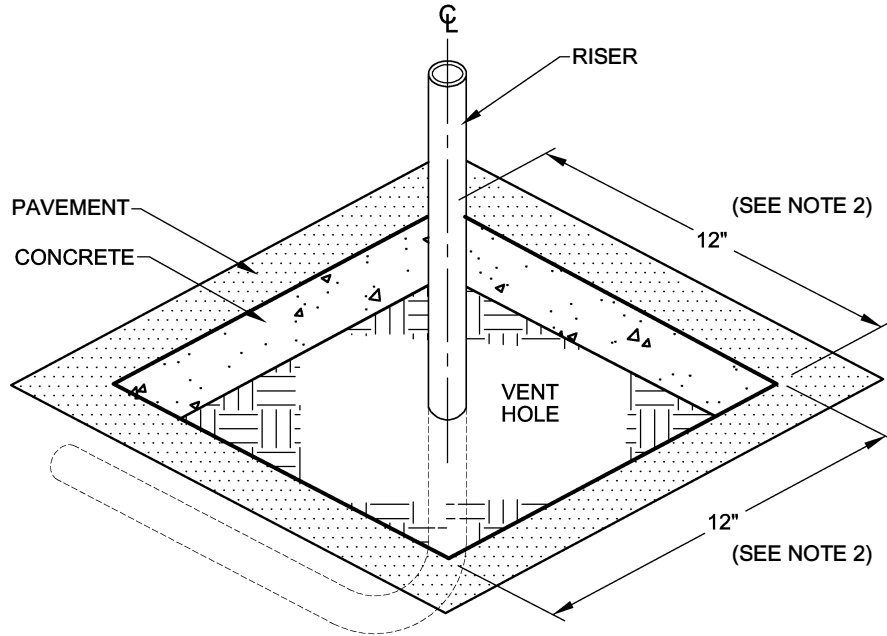

NOTES:

1. The top 6" of vent hole must be filled with dirt, loose gravel or rock to final grade.
2. If the gas meter has been installed before the asphalt or concrete a Field Service Inspector will perform a follow up inspection to verify the 12" x 12" vent hole. As field conditions allow and with Colorado Springs Utilities approval, this can be reduced to a 6" x 6" vent hole with the possible addition of a 4" sleeve or larger around the riser. If the vent hole has not been installed Field Service reserves the right to lock off and/or remove the gas meter until the vent hole is cut into the finished surface.
3. Vent hole is for gas service riser only, and not to be used as a drain or any other application.

FIGURE 3
MOBILE HOMES

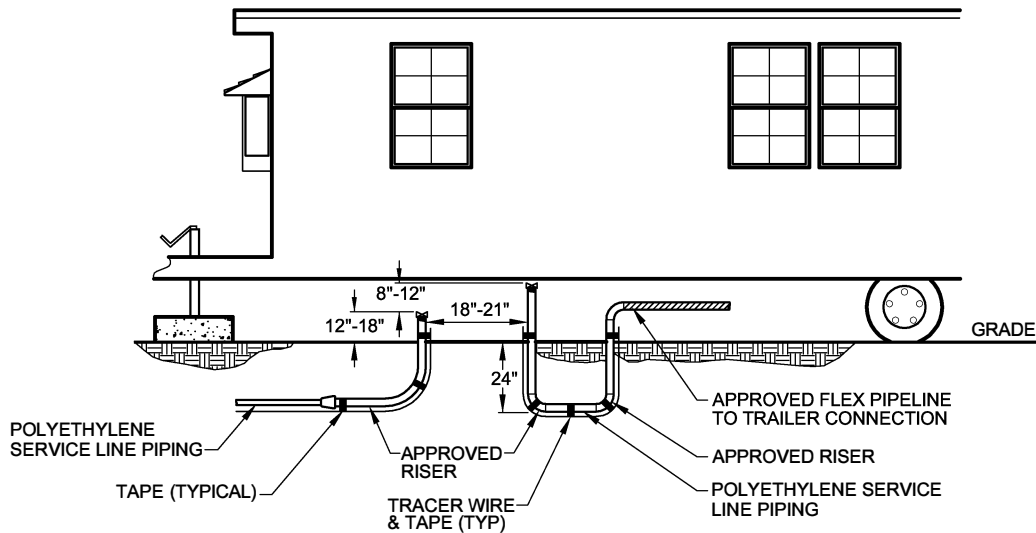
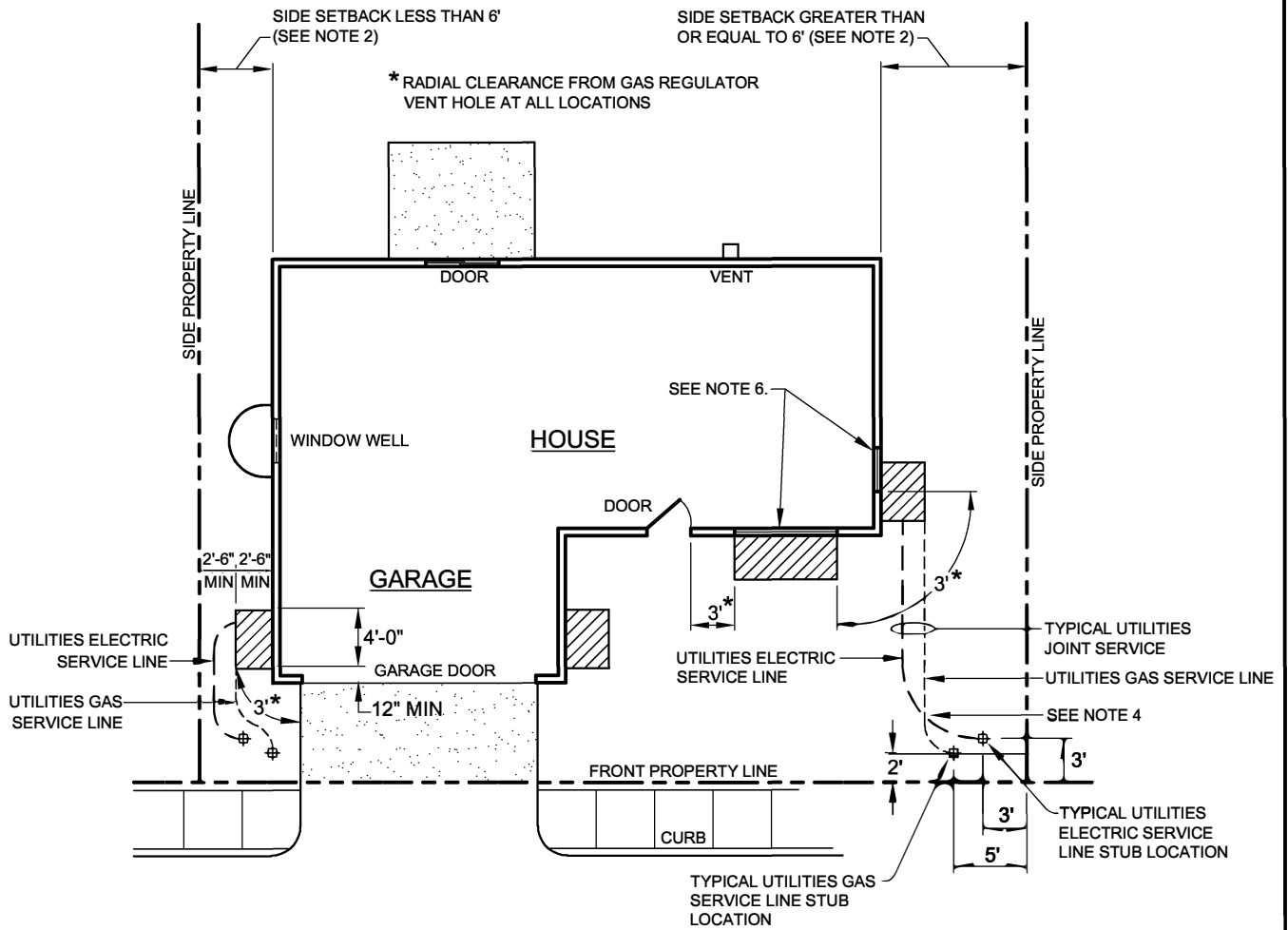



FIGURE 4
UTILITY LOT LAYOUT

FIGURE 4A
COLORADO SPRINGS UTILITIES OWNED JOINT/ SEPARATE TRENCH GAS UTILITIES LOT LAYOUT



GAS METER LOCATION  Gas meter location at front wall or front side wall at 1' minimum and 5' maximum from front corner of building.

NOTES:

1. Residential natural gas meters shall be located on the side of the structure and within 5 feet of the front corner of the structure closest to the gas main, or on the front wall of the structure facing typical public access, or that which is nearest to the gas main. It is preferred, but not mandatory, to have both the natural gas and electric meters located on the same side of the structure.
2. Minimum 2'-6" horizontal separation from property lines, above or below ground structures, and/or other utilities, shall only be allowed where and when residential structures are built on less than a 6' foot setback from the side property line (distance of less than 6' feet between the side wall of the structure and the side property line). Side setbacks greater than or equal to 6 feet will require the typical 3'-0" horizontal separation. Separation clearances at the structure are measured from walls or projections such as foundations, window wells, etc.
3. Typical window well sizes may encroach into the required gas service line clearance space and prohibit installation of the gas service line past that point. The electric service wire may be able to pass by the window well as long as there is the required 12" clearance from the electric service wire to both the window well and the property line.
4. If electric and gas service lines ever need to cross each other, maintain 12" vertical separation between the crossing lines, and maintain 6" bedding sand above and below gas service line.
5. See Figure 4B for Non-Colorado Springs Utilities Lot Layout .
6. Operable window requires 3' radial separation from gas regulator vent hole. Non-operable window is required if located within 3' of gas regulator vent hole (typical).
7. See Figure 9A, 9C and notes for additional requirements regarding meter location.
8. All meters on town homes and single family residential buildings shall be easily accessible for maintenance with no enclosures or fencing.

FIGURE 4 UTILITY LOT LAYOUT

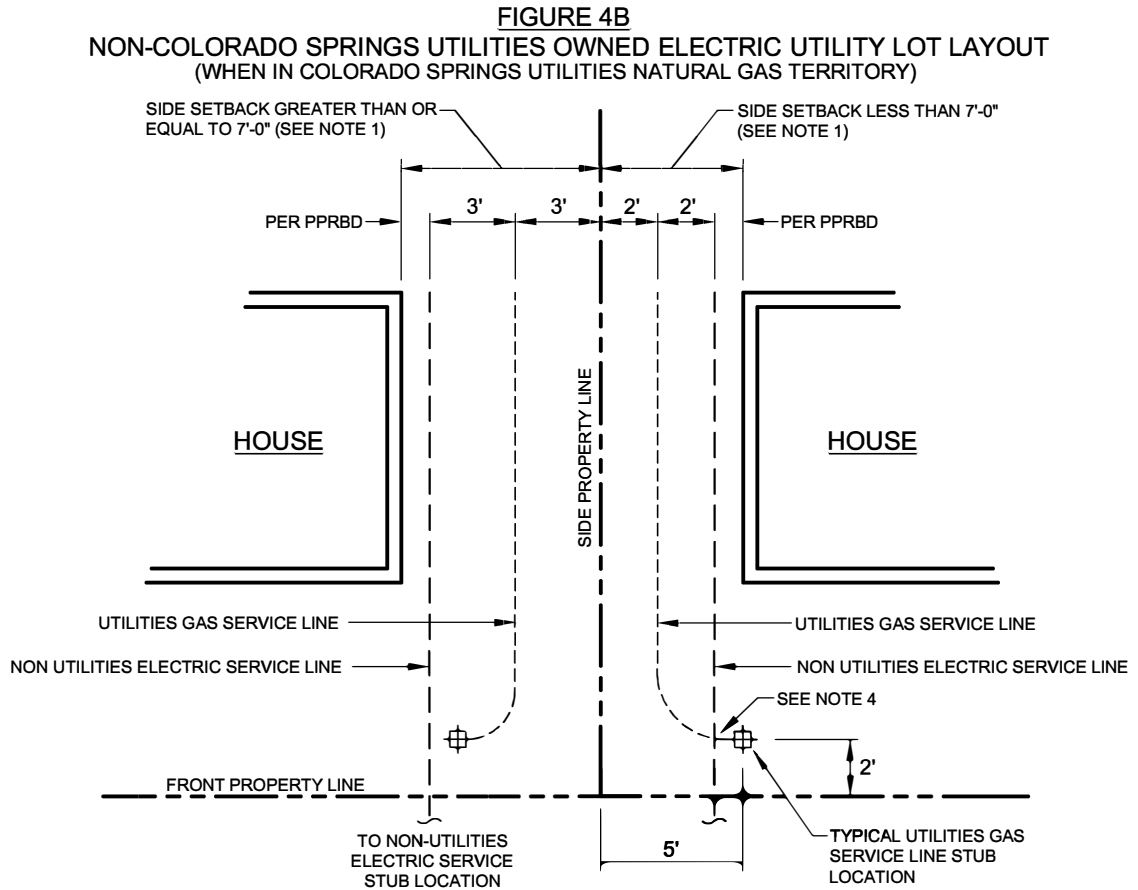

NOTES:

1. For Non-Colorado Springs Utilities service lines (electric or gas) being installed in separate trenches, maintain 3 feet minimum horizontal separation between service lines where the distance between side property line and building is 7 feet or greater. Where and when residential structures are built on a 7 feet or less setback from the side property line (distance of 7 feet or less between side wall of the structure and side property line), reduced clearances shall be allowed as shown in Figure 4B above. For these reduced clearances, maintain 2 feet minimum horizontal separation between gas and electric (or other utility) service line conduit, 2 feet minimum horizontal clearance between gas service line and the building, and 2 feet minimum horizontal clearance between gas service line and the property line. The minimum horizontal separation from electric service line conduit and building and/or property line shall be per Pikes Peak Regional Building Department (PPRBD).
2. Non Colorado Springs Utilities electric service wire shall be installed in a grey electrical rated conduit, which has a minimum diameter of 2" and be either schedule 40 or 80, in all areas where this electric service line has less than 3 feet of horizontal separation from the Colorado Springs Utilities gas service line. This electric conduit shall be placed in the ditch and be ready to be inspected by Colorado Springs Utilities personnel at the same time the gas service line has been scheduled for an inspection and tie-in, so that all clearances and the size and type of conduit can be verified, and its installation approved.
3. Licensed Utility Service Installer (LUSI) is responsible for sand padding 6" around the gas service line with 12" of spoil on top of the sand, before the tie-in and inspection personnel leaves the jobsite address.
4. If electric and gas service lines ever need to cross each other, maintain 12" vertical separation between the crossing lines, and maintain 6" bedding sand above and below gas service line.

FIGURE 5
SERVICE RISER LOCATION DETAILS

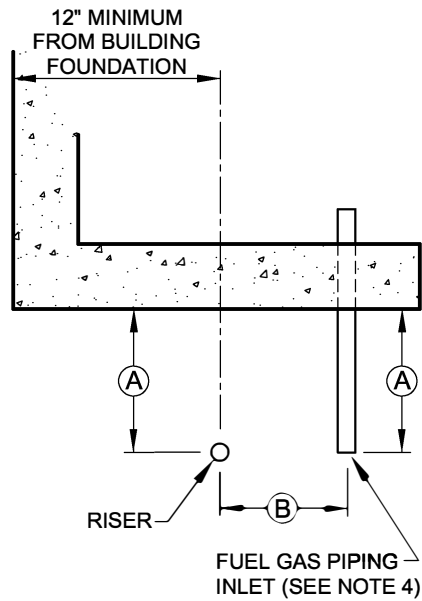

FIGURE 5A
TOP VIEW

TYPICAL 3/4" TO 2" IPS POLYETHYLENE

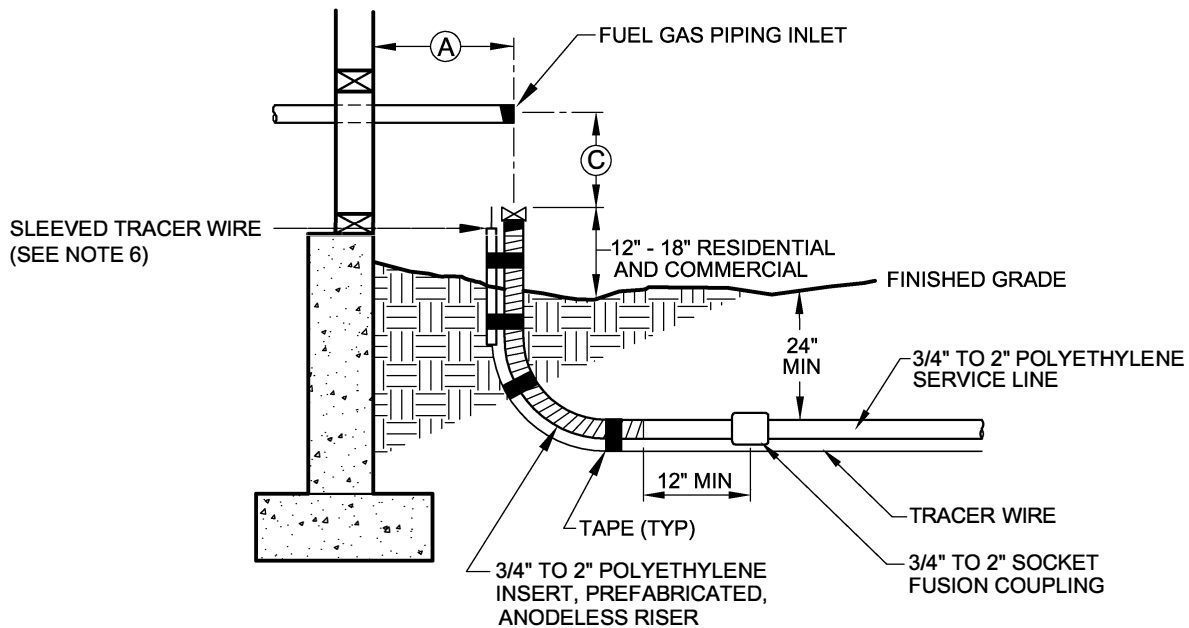
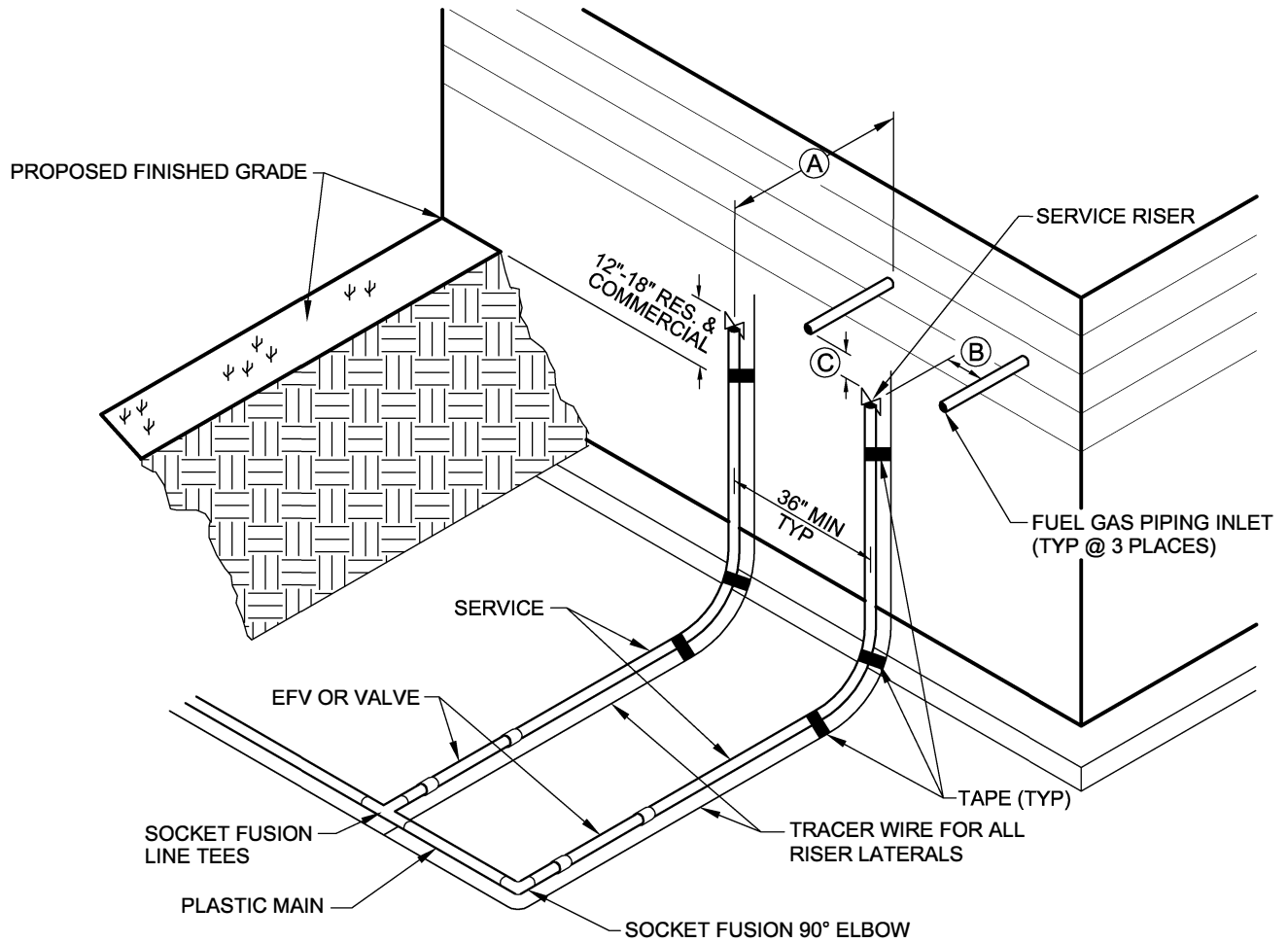

FIGURE 5B
SIDE VIEW

NOTES:

1. After back-filling, the above ground portion of the riser shall be vertical.
2. Starting at the bottom of the anodeless riser, the entire casing shall be field wrapped with an approved UV resistant tape in accordance with Figure 11. There are two options for wrapping: The first option requires field wrapping the riser with H35 UV resistant primerless gray pipe wrap tapecoat with a *recommended* top layer of 3M Scotchrap #50. The second option requires wrapping the riser with M50RCG primerless gray pipe wrap tapecoat and *requires* a layer of UV resistant 3M Scotchrap #50 over the tapecoat. The recommended overlap is 1" or 20% of the tape width, whichever is greater.
3. Contact Colorado Springs Utilities at 668-3570 when expected load exceeds 1,400,001 BTH/HR.
4. All horizontal piping shall be properly secured (i.e., unistrut) to building or structure, as approved by utility inspector.
5. See Figure 6 for A, B & C dimensions.
6. Tracer wire in 1/2IN PE sleeve will extend 6IN below finished grade to the maximum buried depth marked on the riser. The sleeve will be taped to the riser.

FIGURE 6
BELOW GROUND MULTIPLE PARALLEL SERVICES
 (3/4"-2" IPS POLYETHYLENE)



DEPTH OF ENTIRE ASSEMBLY SHALL BE 24" MINIMUM

NOTES:

1. IPS Polyethylene insert riser required for sizes 3/4" to 2".
2. After backfilling, the above ground portion of each riser shall be vertical.
3. Install the tracer wire along all risers. (See Figure 5 notes regarding Sleeved Tracer Wire)
4. A non-standard gas meter loop agreement is required if unable to meet the horizontal and/or vertical loop specifications.

	Ⓐ	Ⓑ	Ⓒ
TOTAL CONNECTED LOAD (BTU/HR)	END OF FUEL GAS PIPING & HORIZONTAL DISTANCE FROM RISER TO BUILDING WALL	HORIZONTAL DISTANCE FROM RISER TO FUEL GAS PIPING INLET	VERTICAL DISTANCE FROM RISER TO FUEL GAS PIPING INLET
390,000 AND LESS	7" - 10"	18" - 21"	8" - 12"
390,001-910,000	16" - 18"	24" - 28"	15" - 24"
910,001-1,400,000 *	16" - 18"	3'	15" - 24"
1,400,001-3,000,000 *	16" - 18" (* 19" - 21")	6'	15" - 24"
3,000,001-10,000,000 *	18" - 20" (* 21" - 23")	**	15" - 24"
GREATER THAN 10,000,000 **	TO BE SPECIFIED BY FIELD ENGINEERING		

NOTE: All commercial gas meter sets require a single riser, shall be a minimum 1-1/4" in size. All commercial risers shall be installed minimum 16" to 18" out from the final exterior finish of the structure.

* Reverse loops are prohibited.

1,400,001 BTU/HR and larger require a concrete meter pad. Dimension "A" requires additional 3" clearance.

** Contact Colorado Springs Utilities Field Service Department/ New Construction (719-668-7350).

*** For core and shell buildings, where load is unknown, all risers shall be 36" apart and horizontal distance from riser to fuel gas piping inlet shall be 30".

FIGURE 7
ABOVE GROUND MULTIPLE METER MANIFOLD
FUEL LINE/RISER CONFIGURATION
RESIDENTIAL ONLY (NO COMMERCIAL)

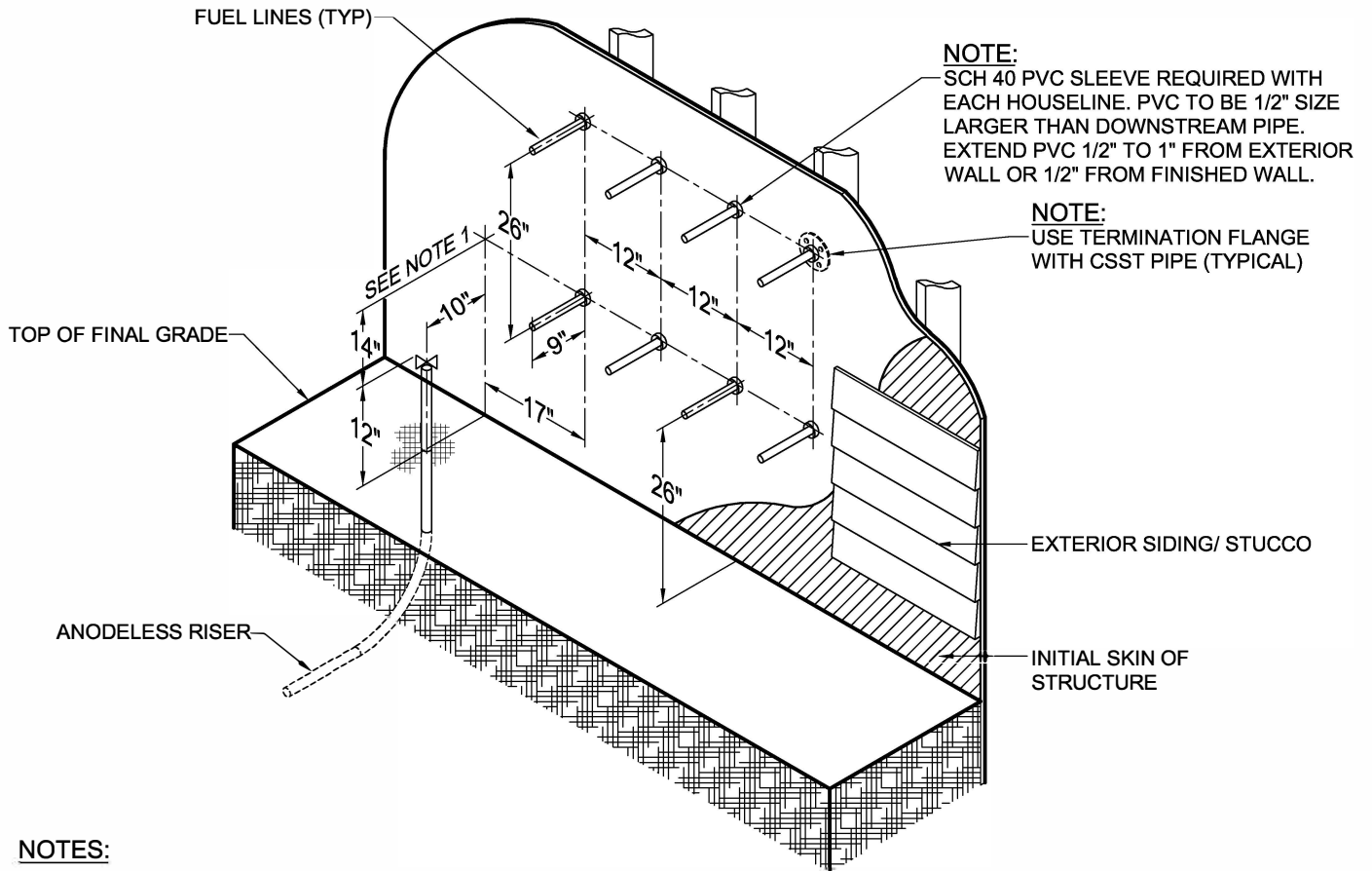

NOTES:

1. FUEL LINES TO BE 14" ABOVE THE TOP OF VALVE BODY (TYPICAL)
2. Centerline of riser must be 10" from final exterior finish. For any questions on manifold design, service riser placement, or customer fuel piping measurements, please call 668-7350 for further instructions.
3. All fuel lines shall be 1" or 3/4" black iron threaded piping, depending on load of each unit, otherwise approved in writing by Colorado Springs Utilities Planning and Engineering Department, Field Engineering. Fuel lines shall extend 9" from the final finish of the structure. (Final finish shall mean the outside surface layer, such as stucco or other final exterior siding). Whenever corrugated stainless steel piping (CSST) is used as interior piping, black iron threaded piping and termination flange must be used for the portion of the fuel piping that extends through the structure wall.
4. Maximum number of meters is 24 (3 rows of 8).

POTENTIAL METER CONFIGURATION



FIGURE 8
TYPICAL METER SETS

FIGURE 8A
TYPICAL RESIDENTIAL METER SET
0 - 390,000 (BTU/HR)

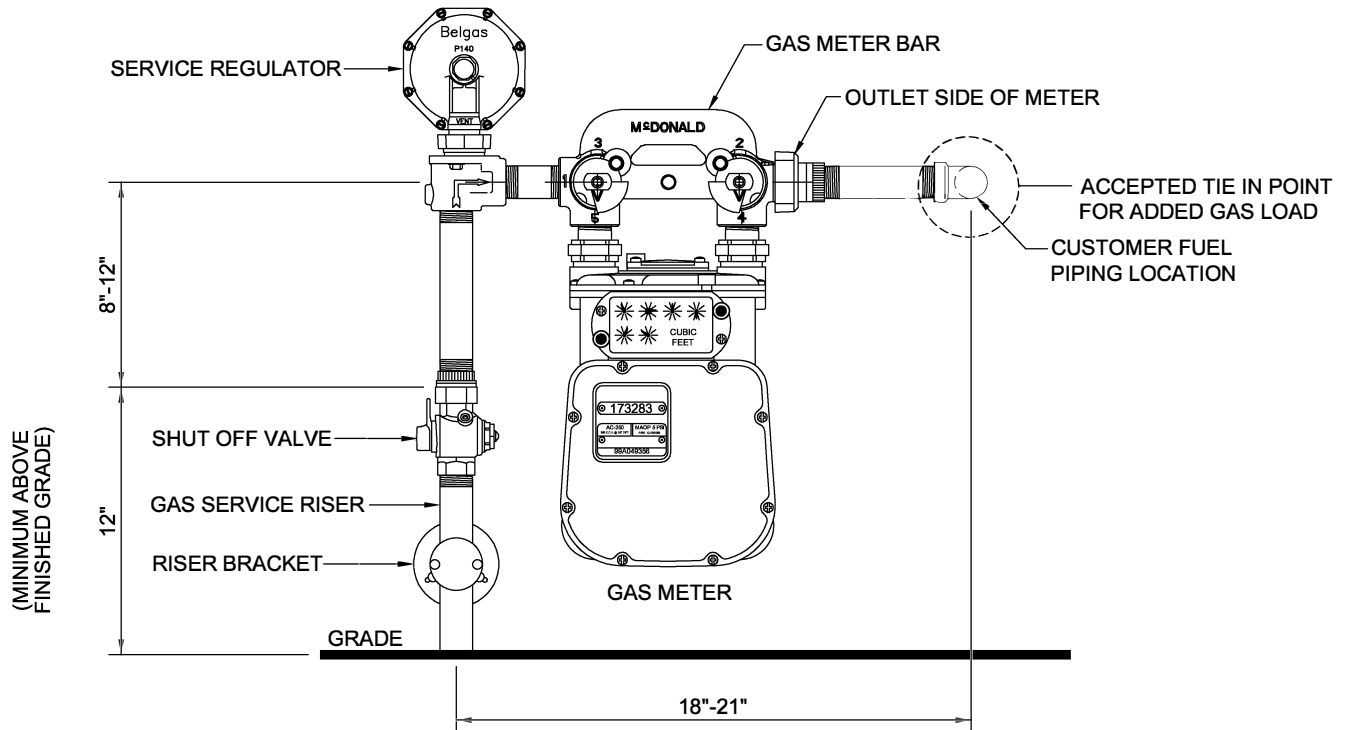

NOTE:
SEE TABLE 7 FOR APPROVED MANUFACTURERS
FOR TYPICAL METER SET MATERIALS.

METER LOOP SPECIFICATIONS:

APPLICATION: TOTAL CONNECTED LOAD OF 390,000 BTU/HR OR LESS

GAS SERVICE RISER: 7" - 10" OUT FROM THE FINAL EXTERIOR FINISHED SURFACE

COMMERCIAL RISERS: 16" - 18" OUT FROM THE FINAL EXTERIOR FINISHED SURFACE

REQUIRED DISTANCE FROM FINISHED EXTERIOR WALL TO END OF CUSTOMER FUEL PIPING IS 1" SHORTER THAN CENTER OF RISER VALVE. MUST BE ONE CONTINUOUS PIPE WITH NO FITTINGS (I.E., COUPLINGS)

HORIZONTAL SPREAD: 18" - 21" (CENTER OF GAS RISER TO CENTER OF FUEL LINE)

VERTICAL SPREAD: 8" - 12" (TOP OF GAS RISER VALVE TO FUEL LINE INLET)
: 12" - 16" (VERTICAL SPREAD WITH 2" RISER)

GAS RISER SHUT OFF VALVE: NEED TO BE A MINIMUM OF 12" FROM FINISHED GRADE

SEE CHAPTER 4 [4.05d)3)d)1)i)] FOR ADDITIONAL REQUIREMENTS WHEN METERS ARE LOCATED NEAR TRANSFORMERS AND GENERATORS.

FIGURE 8B
390,001 - 910,000 (BTU/HR)

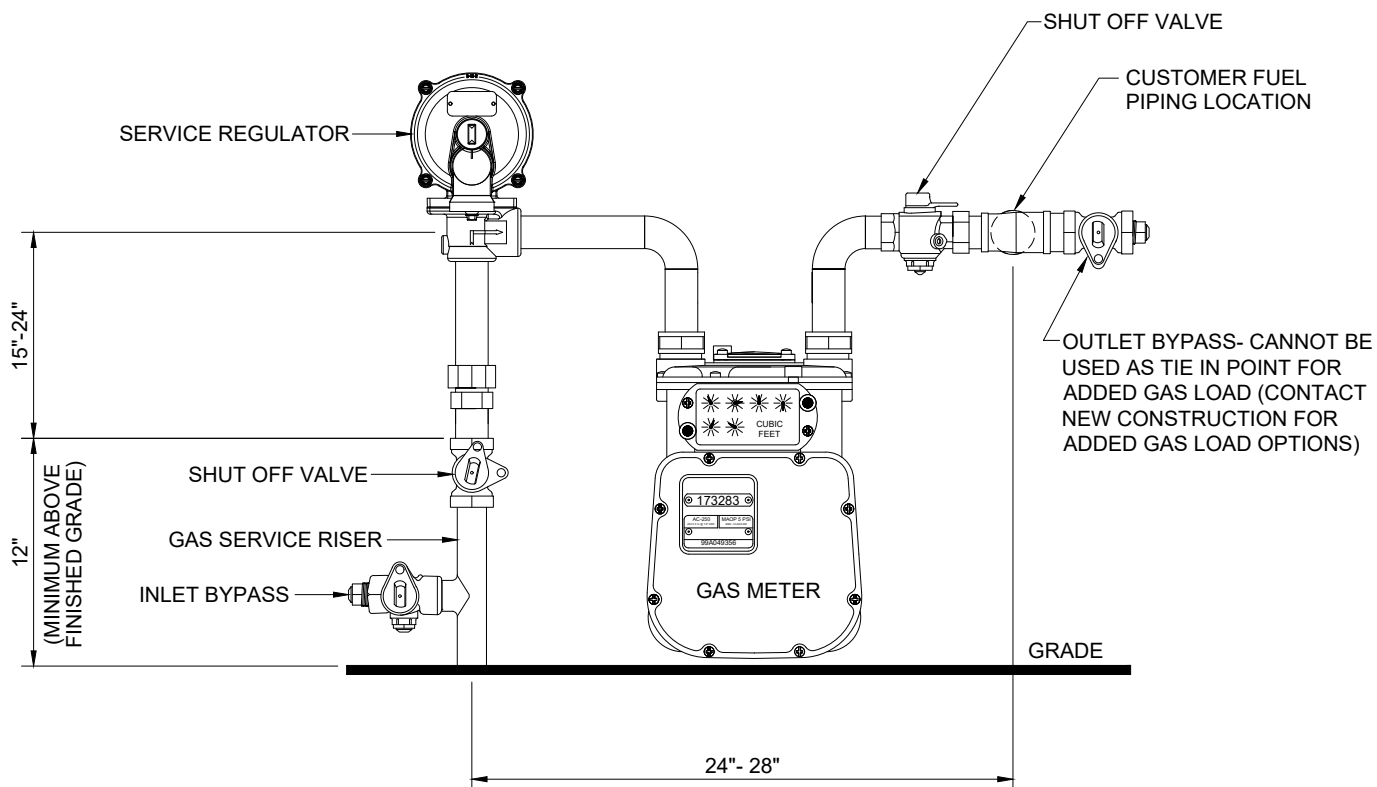

NOTE:
SEE TABLE 7 FOR APPROVED MANUFACTURERS
FOR TYPICAL METER SET MATERIALS.

NOTE:
RISER BRACKETS ARE NOT REQUIRED ON COMMERCIAL
INSTALLATIONS (PENDING FINAL APPROVAL FROM
FIELD SERVICES)

METER LOOP SPECIFICATIONS:

APPLICATION: TOTAL CONNECTED LOAD OF 390,001 - 910,000 BTU/HR OR LESS

GAS SERVICE RISER: 16" - 18" OUT FROM THE FINAL EXTERIOR FINISHED SURFACE

COMMERCIAL RISERS: 16" - 18" OUT FROM THE FINAL EXTERIOR FINISHED SURFACE

REQUIRED DISTANCE FROM FINISHED EXTERIOR WALL TO END OF CUSTOMER FUEL PIPING IS 1" SHORTER THAN CENTER OF RISER VALVE. MUST BE ONE CONTINUOUS PIPE WITH NO FITTINGS (I.E., COUPLINGS)

HORIZONTAL SPREAD: 24" - 28" (CENTER OF GAS RISER TO CENTER OF FUEL LINE)

VERTICAL SPREAD: 15" - 24" (TOP OF GAS RISER VALVE TO FUEL LINE INLET)

GAS RISER SHUT OFF VALVE: NEED TO BE A MINIMUM OF 12" FROM FINISHED GRADE

SEE CHAPTER 4 [4.05d)3)d)1)ii)] FOR ADDITIONAL REQUIREMENTS WHEN METERS ARE LOCATED NEAR TRANSFORMERS AND GENERATORS.

FIGURE 8C

910,001 - 1,400,000 (BTU/HR)

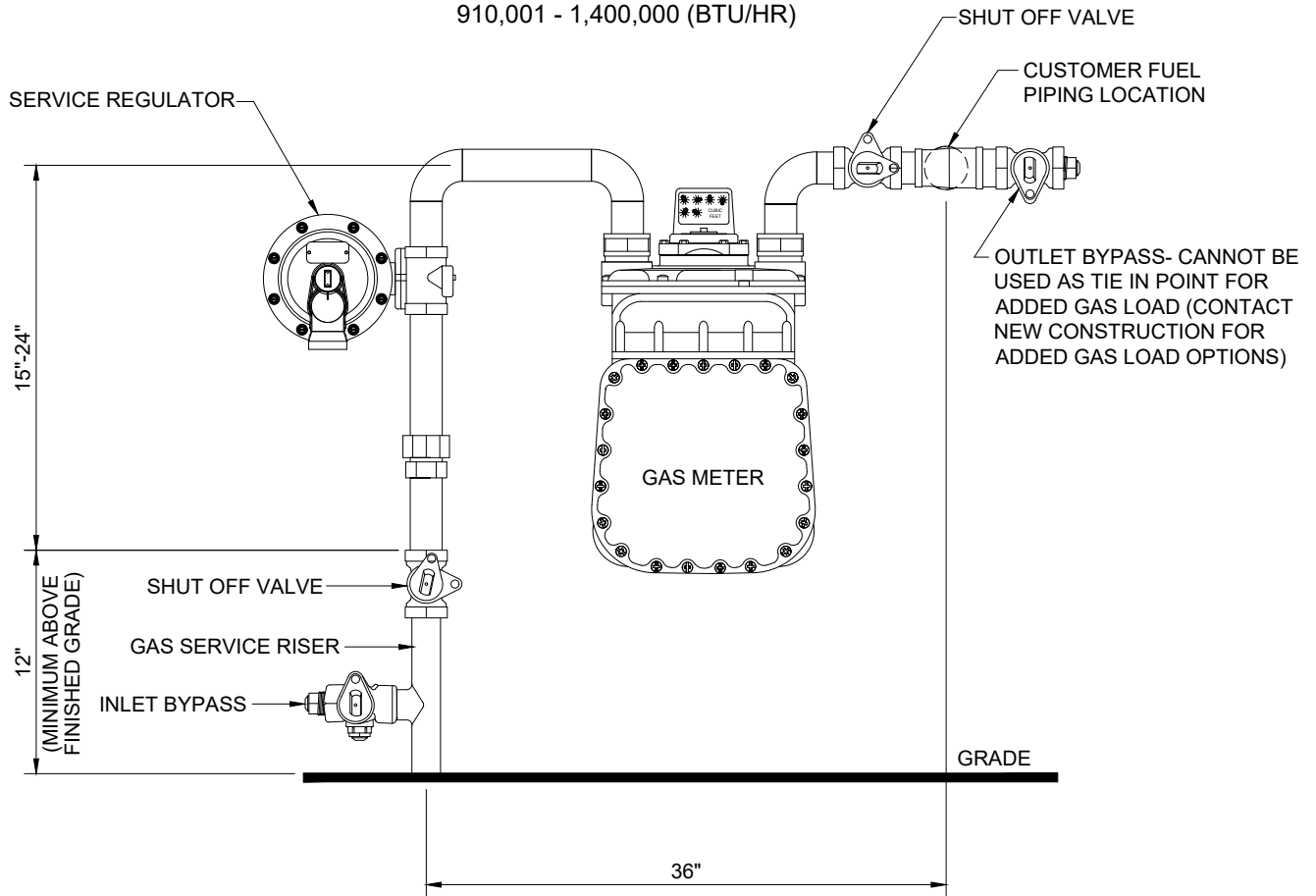

NOTE:
SEE TABLE 7 FOR APPROVED MANUFACTURERS
FOR TYPICAL METER SET MATERIALS.

NOTE:
RISER BRACKETS ARE NOT REQUIRED ON COMMERCIAL
INSTALLATIONS (PENDING FINAL APPROVAL FROM
FIELD SERVICES)

METER LOOP SPECIFICATIONS:

APPLICATION: TOTAL CONNECTED LOAD OF 910,001 - 1,400,000 BTU/HR OR LESS

GAS SERVICE RISER: 16" - 18" OUT FROM THE FINAL EXTERIOR FINISHED SURFACE

COMMERCIAL RISERS: 16" - 18" OUT FROM THE FINAL EXTERIOR FINISHED SURFACE

REQUIRED DISTANCE FROM FINISHED EXTERIOR WALL TO END OF CUSTOMER FUEL PIPING IS 1" SHORTER THAN CENTER OF RISER VALVE. MUST BE ONE CONTINUOUS PIPE WITH NO FITTINGS (I.E., COUPLINGS)

HORIZONTAL SPREAD: 36" (CENTER OF GAS RISER TO CENTER OF FUEL LINE)

VERTICAL SPREAD: 15" - 24" (TOP OF GAS RISER VALVE TO FUEL LINE INLET)

GAS RISER SHUT OFF VALVE: NEED TO BE A MINIMUM OF 12" FROM FINISHED GRADE

LOAD INCREASES IN WHICH THE TOTAL LOAD EXCEEDS 1,000,000 BTU CONTACT FIELD ENGINEERING FOR SERVICE LINE APPROVAL.

SEE CHAPTER 4 [4.05d)3)d)1)i)] FOR ADDITIONAL REQUIREMENTS WHEN METERS ARE LOCATED NEAR TRANSFORMERS AND GENERATORS.

FIGURE 8D
TYPICAL COMMERCIAL METER SET
1,400,001 - 3,000,000 (BTU/HR)

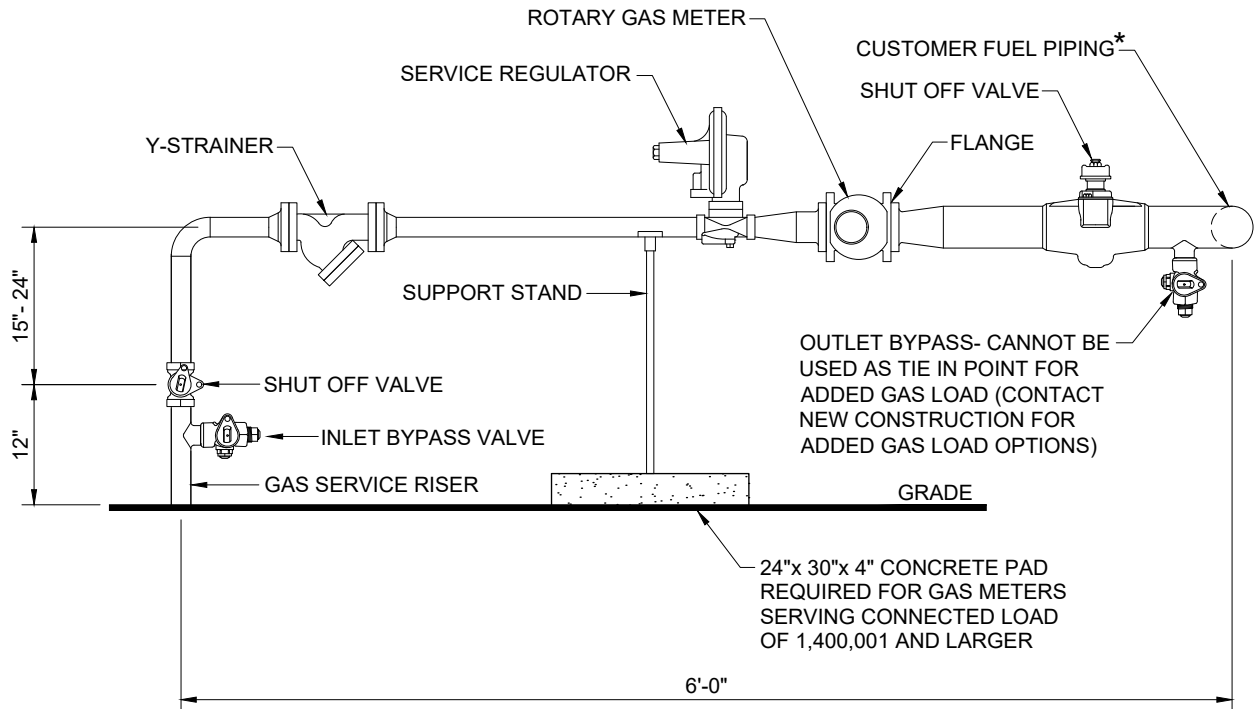

NOTE:
 RISER BRACKETS ARE NOT REQUIRED ON COMMERCIAL INSTALLATIONS (PENDING FINAL APPROVAL FROM FIELD SERVICES)

METER LOOP SPECIFICATIONS:

APPLICATION: TOTAL CONNECTED LOAD OF 1,400,001 - 3,000,000 BTU/HR OR LESS

GAS SERVICE RISER: 16" - 18" OUT FROM THE FINAL EXTERIOR FINISHED SURFACE

FUEL LINE STUB: EQUAL DISTANCE OUT FROM THE FINAL EXTERIOR FINISHED SURFACE AS RISER

HORIZONTAL SPREAD: 6' (CENTER OF GAS RISER TO CENTER OF FUEL LINE)

VERTICAL SPREAD: 15" - 24" (TOP OF GAS RISER VALVE TO FUEL LINE INLET)

GAS RISER SHUT OFF VALVE: NEED TO BE A MINIMUM OF 12" FROM FINISHED GRADE

CONFIGURATION: NORMAL (AS PICTURED ABOVE; GAS RISER LEFT OF GAS METER) OR VERTICAL (TOP INLET) ONLY. REVERSE LOOPS ARE PROHIBITED.

* SEE CHAPTER 4 [4.05d)3)d)1)i)] FOR ADDITIONAL REQUIREMENTS WHEN METERS ARE LOCATED NEAR TRANSFORMERS AND GENERATORS.

NOTES:

LOADS BETWEEN 1,400,001 AND 1,600,000, CONTACT COLORADO SPRINGS UTILITIES FIELD SERVICE DEPARTMENT NEW CONSTRUCTION AT (719) 668-7350 PRIOR TO HOUSE LINE INSTALLATION.

FIGURE 9
METER LOOP LOCATION & CLEARANCES

FIGURE 9A
TYPICAL RESIDENTIAL METER LOCATION
(GROUPED ELECTRIC, GAS, WATER)

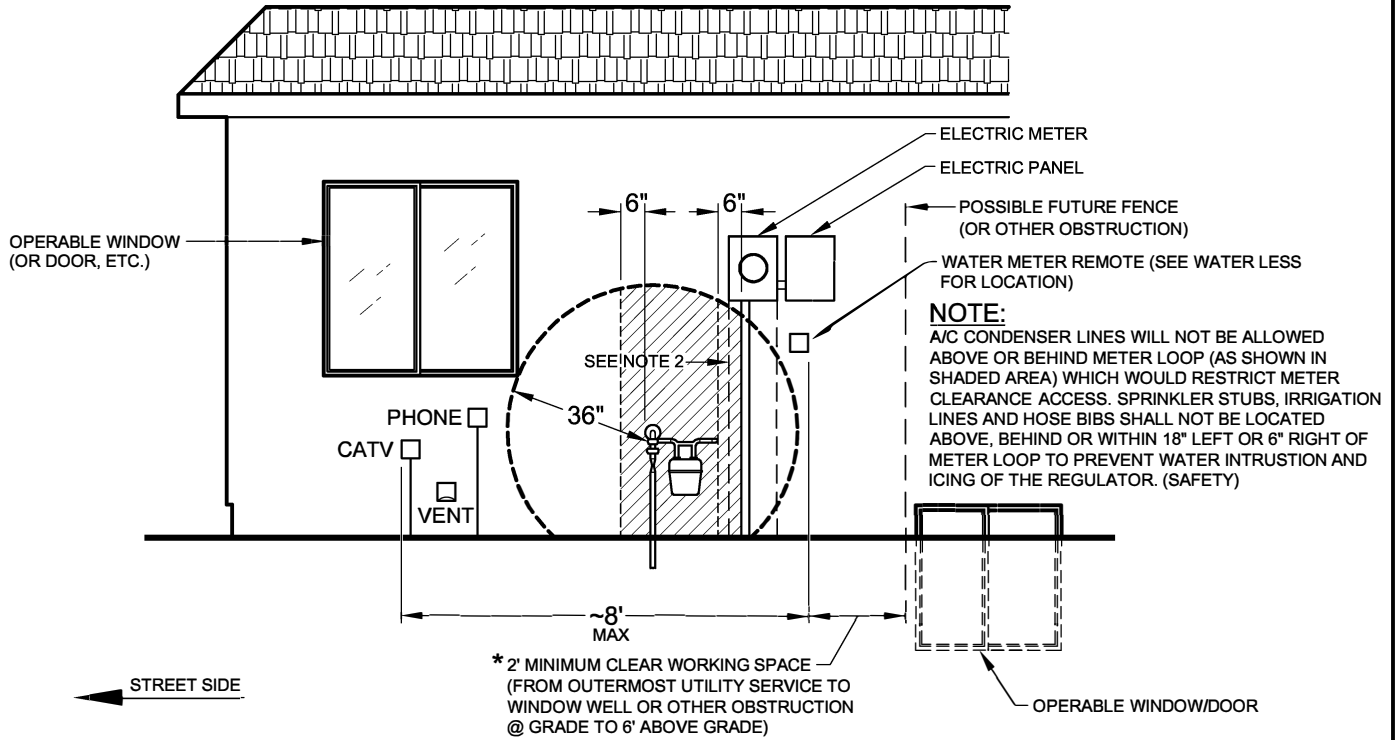
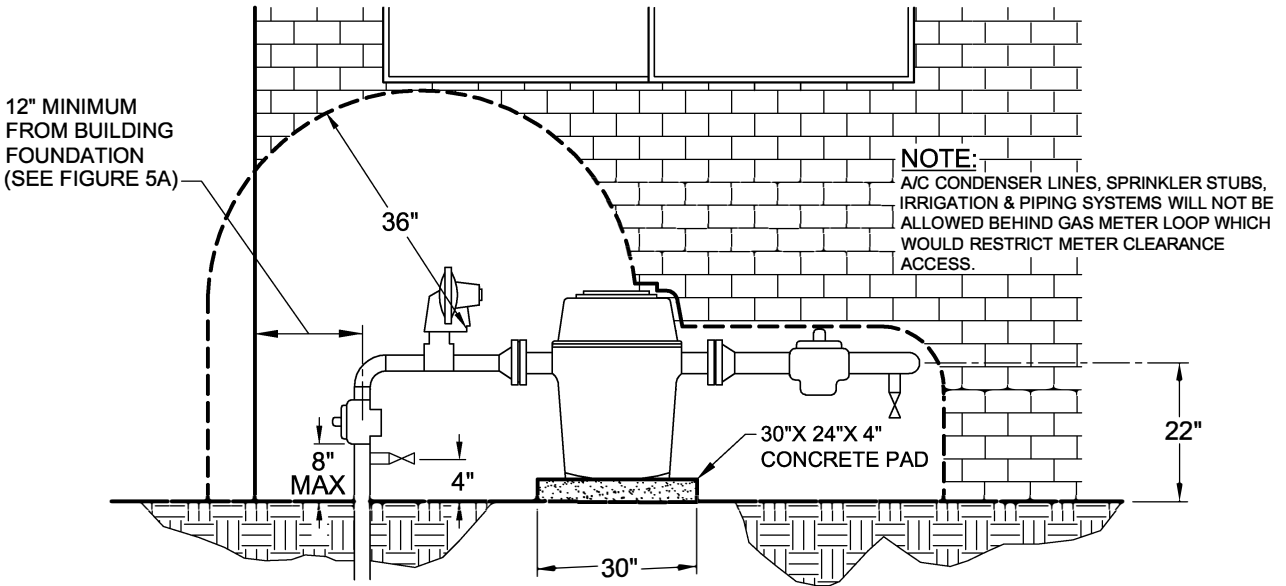

FIGURE 9B
TYPICAL COMMERCIAL METER LOCATION



NOTES:

1. No vents, sump pump vents, operable windows, doors, chimney, air conditioning units, heat generating devices, sources of ignition (to include electric meter socket and panel), or other openings into the building allowed within 3 feet of the regulator vent hole (The service regulator vent hole is at the same height as the fuel gas piping inlet).
2. All above ground Colorado Springs Utilities meter loop must maintain 36" minimum clear working space to include landscaping (e.g., trees, bushes).
3. Three feet (3'-0") clearance required in front and radial of the meter (with exception of bollards).
4. For generator separation distance to gas meter, see ELESS 18-227.
5. It is preferred that natural gas generators, in commercial applications, be installed with their own separate meter.

FIGURE 9C
TYPICAL RESIDENTIAL GROUPED METER LOCATIONS
AT JOINT SERVICE INSTALLATION (GAS & ELECTRIC)

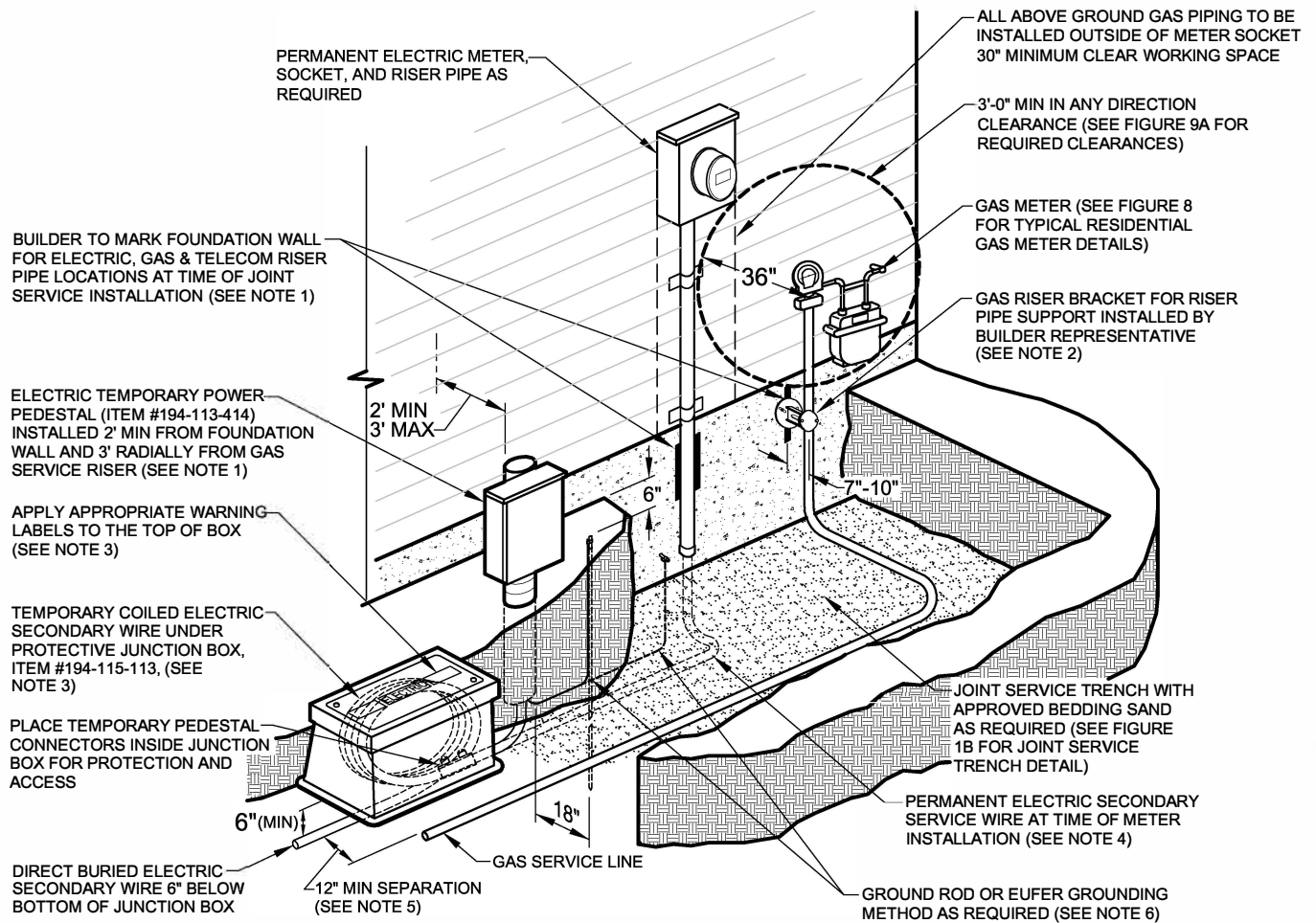

JOINT SERVICE TRENCH (GAS & ELECTRIC) RESIDENTIAL METER LOCATION

NOTES:

1. Joint Service trench to be installed at the foundation stage of the residence construction. As part of the trench installation, the electric temporary power pedestal is to be relocated from the property line to 3 feet (maximum) from the foundation wall of the residence. Install the gas service line in same trench. The builder is required to mark the foundation wall for the electric, gas and telecom riser pipe locations (use red for electric, yellow for gas, and orange for telecom). The electric temporary power pedestal shall maintain a 3 foot radial clearance from the gas riser pipe location (see Figure 9A for required radial clearances). See Electric DCS 8-6 for temporary power pedestal details.
2. Builder's representative to install gas riser support bracket to foundation wall and connect to gas riser pipe at time of riser pipe installation. Builder's representative shall use the concrete anchor bolts (unless equal size and quality substitute is approved by the QC Inspector Supervisor) and materials included with the riser bracket for installation to the foundation. See Table 7 for riser bracket and riser pipe approved manufacturers.
3. Coil 15-20 feet of extra secondary electric wire vertically in a 24" minimum diameter loop and store below grade under a protective junction box. Keep box and loop close to the temporary power pedestal and 12" minimum distance from the gas service line. At time of permanent electric meter installation, remove temporary power pedestal and terminate coiled wire into permanent meter socket after passing required electric inspection. Apply warning labels to the top of the protective box, Item Number 194-113-417 (english), and Item Number 194-113-418 (spanish). See Electric DCS 8-6 for protective box details.
4. Provide 6" cable slack at bottom of electric riser for possible future grade settling.
5. Maintain 12" minimum clearance at all times between the gas and electric service lines (CSU owned services only).
6. Effectively ground temporary power pedestal utilizing either a ground rod or Euferr grounding method as required.

FIGURE 10
METER PROTECTION

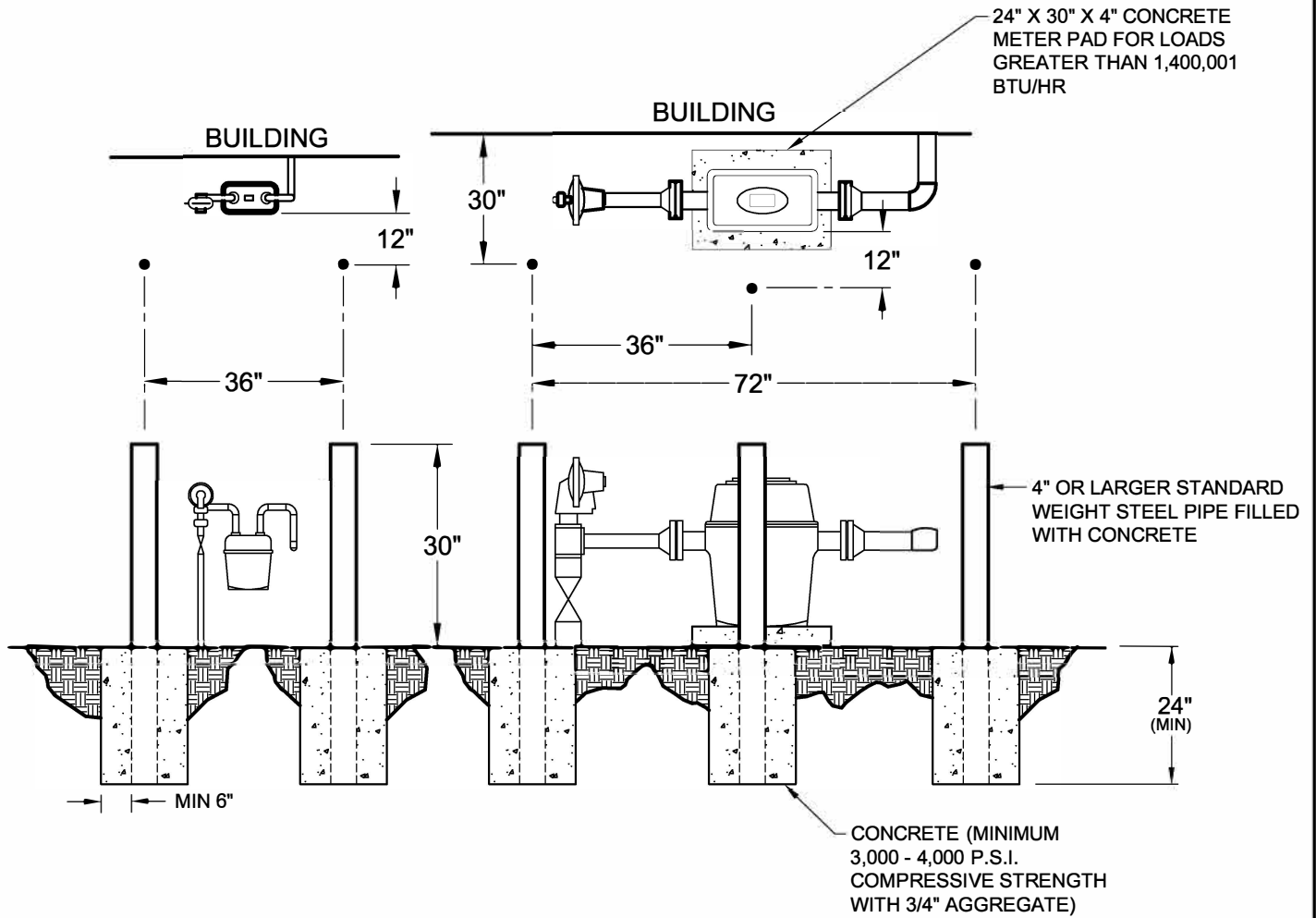

NOTE:

1. All guard posts (bollards) must be installed before meter is set.
2. If additional hazards arise in the future, Colorado Springs Utilities reserves the right to require additional meter protection at owner's expense.

FIGURE 11
FIELD WRAPPING

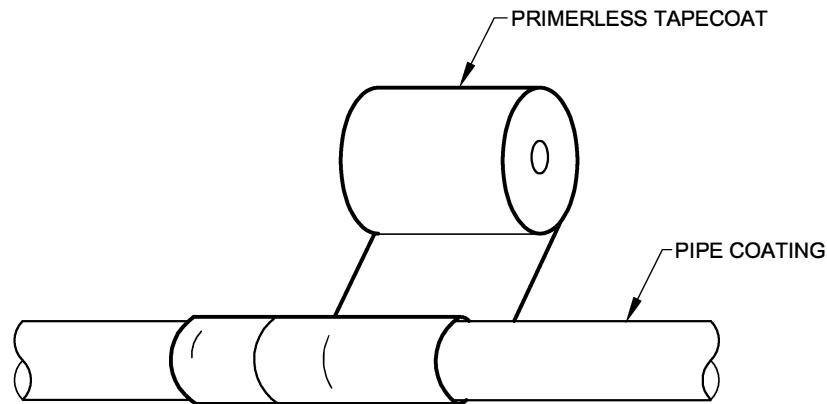
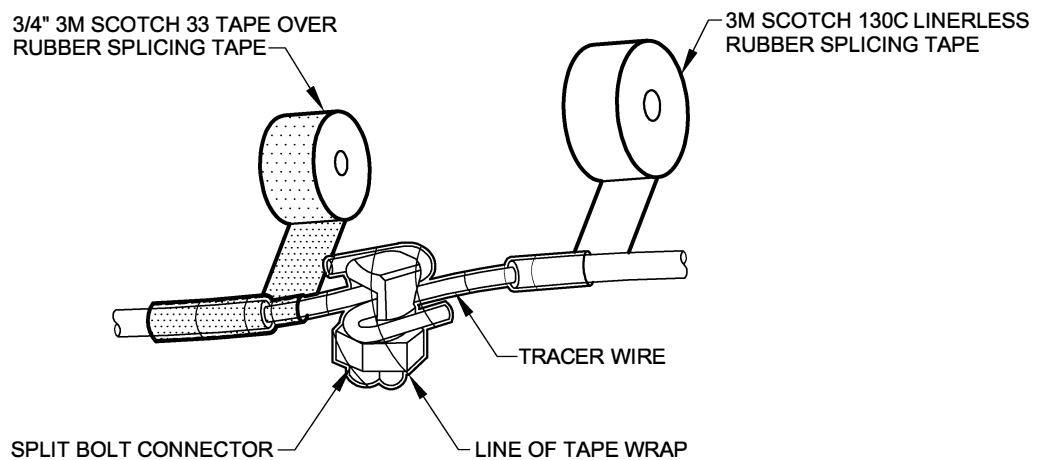

FIGURE-A



SPLIT BOLT TAPING

NOTES:

1. All welded joints, bare steel pipe, fittings or damaged portions of the pipe coating shall be wrapped as shown in Figure-A.
2. Trim any loose or disbonded coating from pipe. Remove dirt and moisture from pipe coating area where tape is to be applied.
3. Apply primerless tapecoat a minimum of 2" beyond damaged portion of coating, bare pipe, fittings, wire connection or weld joint. Firmly apply tape.
4. Wrap all Tracer Wire split bolt connectors using 3/4" 3M Scotch 130C linerless rubber splicing tape, with 3/4" Scotch 33 tape over. Extend wrap 2" on both sides of connector.
5. Wrap tape around tracer wire and service line a minimum of 3 wraps every 8' to 10' of service line and riser.

FIGURE 12
MERCURY CORRECTOR & COMMUNICATION MODEM

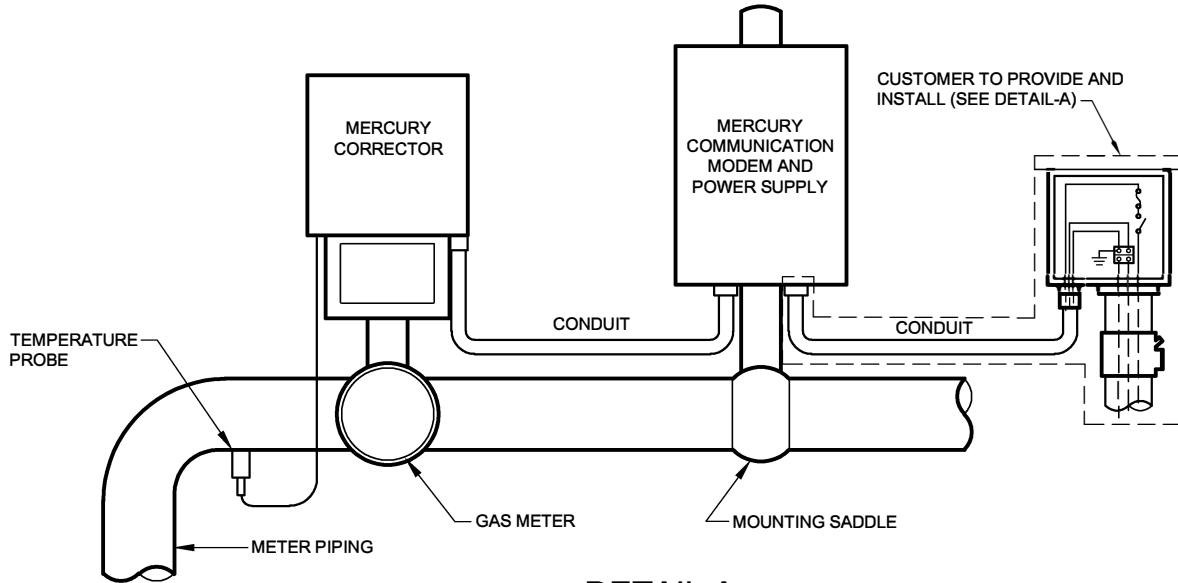

DETAIL A
TYPICAL WIRING DIAGRAM

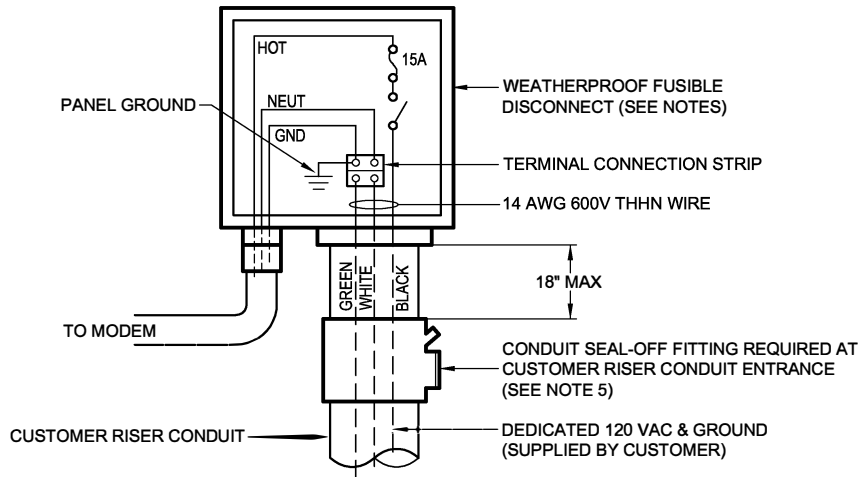

NOTES:

1. The Mercury Corrector and Communication Modem monitors and adjusts pressure and temperature on customer natural gas lines, and communicates this information to the MV90 system.
2. Any gas meter installation which requires a compensation instrument and associated communication device for a specific gas tariff the customer will be required at their cost to provide a dedicated 120V electric circuit to the gas metering facility. Connections of the 120V circuit to Utilities' equipment will also be provided at the customers cost, per URR Natural Gas 28, Sheet 52.
3. All 120V electrical wiring requirements/activities and permitting shall be the responsibility of the customer, to include termination at the Mercury Communications Modem & Power Supply.
4. Maintain 3' minimum radial separation between any source of ignition and gas regulator vent, per NFPA 54-2009 5.8.5.1(3). Do not exceed 10' from meter location.
5. All enclosures, raceways, and connections within 3' of the regulator shall be constructed together in a manner to provide intrinsically safe equipment and barriers between potential ignition sources and natural gas. Use "liquid tight" style flexible conduit and connectors between components and seal-off connectors at the Nema 3 enclosure opening.
6. As per NEC 500.5(B)2, this installation falls into a Class 1, Division 2 area, as such the requirements for sealing off the customer riser conduit shall comply with NEC 501.15. Seal Off fitting shall be installed within 18" of the steel enclosure.
7. Customer to provide and install a Cutler Hammer Fusible Disconnect (Model #DPF221RP), or equal per Note 3. CSU will provide fuses upon installation of the metering instruments.
8. The Mercury Corrector and Communication Modem shall be installed on same side of the insulating gasket assembly to maintain proper cathodic protection.

FIGURE 13
PULSE-INITIATING DEVICE TO MONITOR GAS USAGE

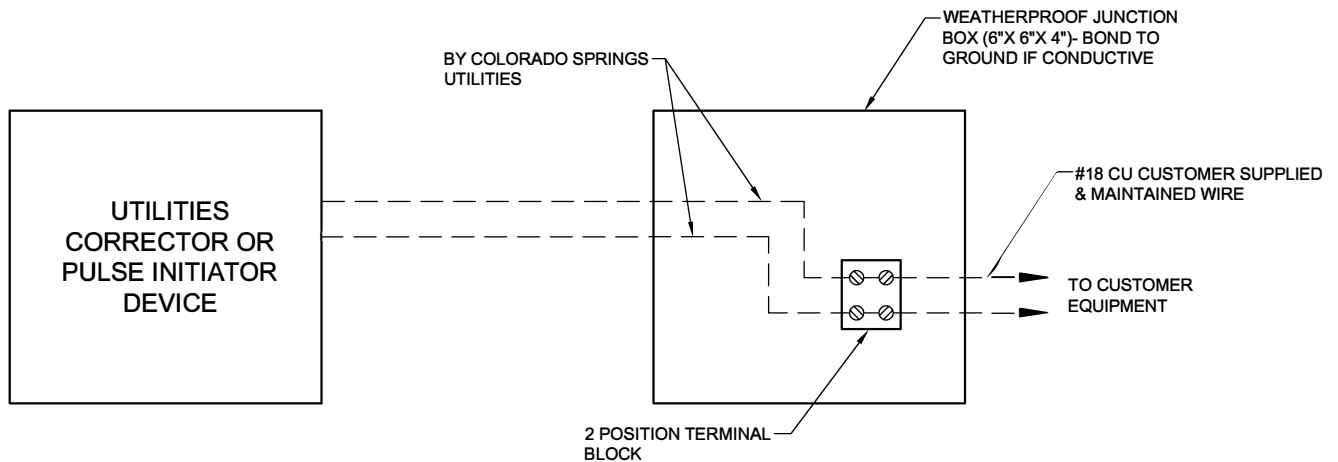

GAS PULSE-INITIATING DEVICE INSTALLATION

NOTES:

1. Upon the customer's request, Colorado Springs Utilities will install a pulse-initiating device on a customer's existing gas meter with an additional installation charge and a monthly charge. To initiate a request for a pulse-initiating device, the customer shall contact the Advanced Measurement Technologies Supervisor (see Phone Section). Colorado Springs Utilities will determine what type of pulse and the pulse value for customers.
2. To get the pulse-initiating device installed, the customer will install a weatherproof junction box at least 36 inches from the gas regulator but not to exceed 5 feet from the meter, and a 2 position terminal block inside of the junction box. The customer will also furnish and install a low voltage DC 2 to 5 conductor wire not to exceed 24 volts DC, and maintain the wiring from the 2 position terminal block to the customer's monitoring equipment. This wiring will be in accordance with the requirements of the electrical code governing such installations with Colorado Springs. Colorado Springs Utilities will then install the pulse-initiating device and wiring from the gas meter to the terminal block.

Note: Colorado Springs Utilities responsibility and liability ends at the line side of the terminal block.

FIGURE 14

REQUIRED AIR PRESSURE TEST GAUGE & BLOW DOWN ASSEMBLY

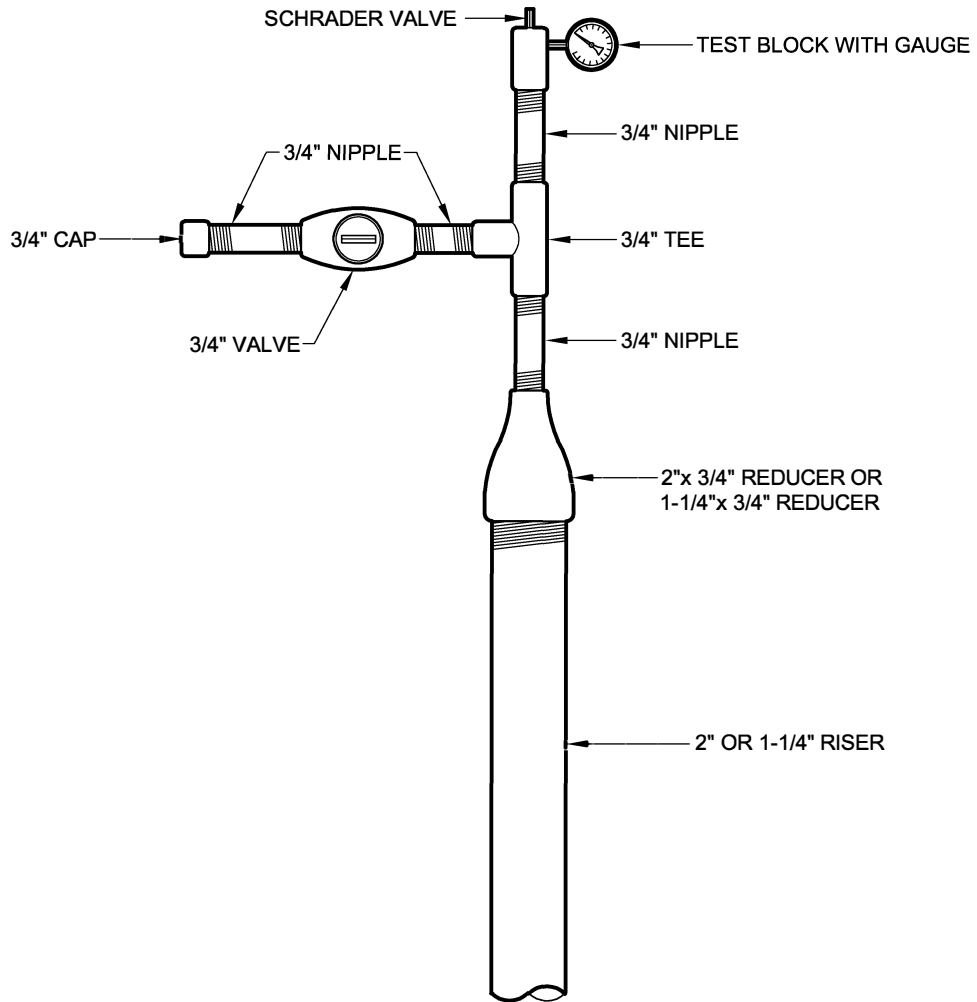

NOTE:

This assembly shall be provided by the Licensed Utility Service Installer on all 1-1/4" or 2" welded steel or anodeless gas service riser installations.

FIGURE 15
BOLLARD POST INSTALLATIONS

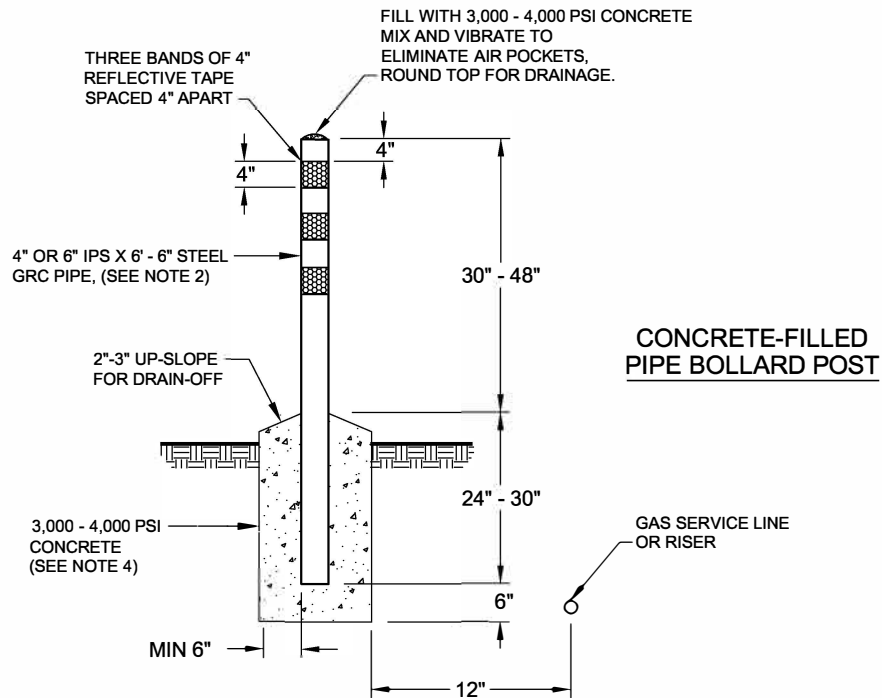

NOTES:

1. Bollard posts to be installed plumb and level across the tops from one to another when two are used.
2. Use scrap 4" or 6" GRC pipe and paint with two coats of silver or yellow paint, unless conduit piece is new.
3. Dig 20" x 36" hole- conduit to be centered in hole.
4. Concrete for anchoring posts to be 3,000 - 4,000 psi, approximately 8.3 Cu.Ft./Pole.
5. Use bands of reflective tape on top of posts to warn motorists, cyclists, etc. The first band should be no lower than 4" from the top of the post.
6. See Figure 10 for meter protection; however, Field Engineering will make the determination on bollard height requirements. All bollards at the same site will be the same height.
7. Space posts to prevent vehicle from contacting meter set but leave room for meter access and maintenance.
8. Bollards may not be installed directly over utility infrastructure and the horizontal base of the concrete must be located a horizontal distance of 12" from a gas service line.
9. Bollards must be installed using hydroexcavation or hand dug within 18" of service line. Use of sonotubes is encouraged.

FIGURE 16

JOINT TRENCH - FRONT LOT LAYOUT WITH DETACHED SIDEWALKS AND TREES BEHIND CURB

(THIS LAYOUT ACCOUNTS FOR 6' SEPARATION FROM ELECTRIC AND GAS LINES TO TREES) (50' R.O.W. AND 5' SIDEWALKS)

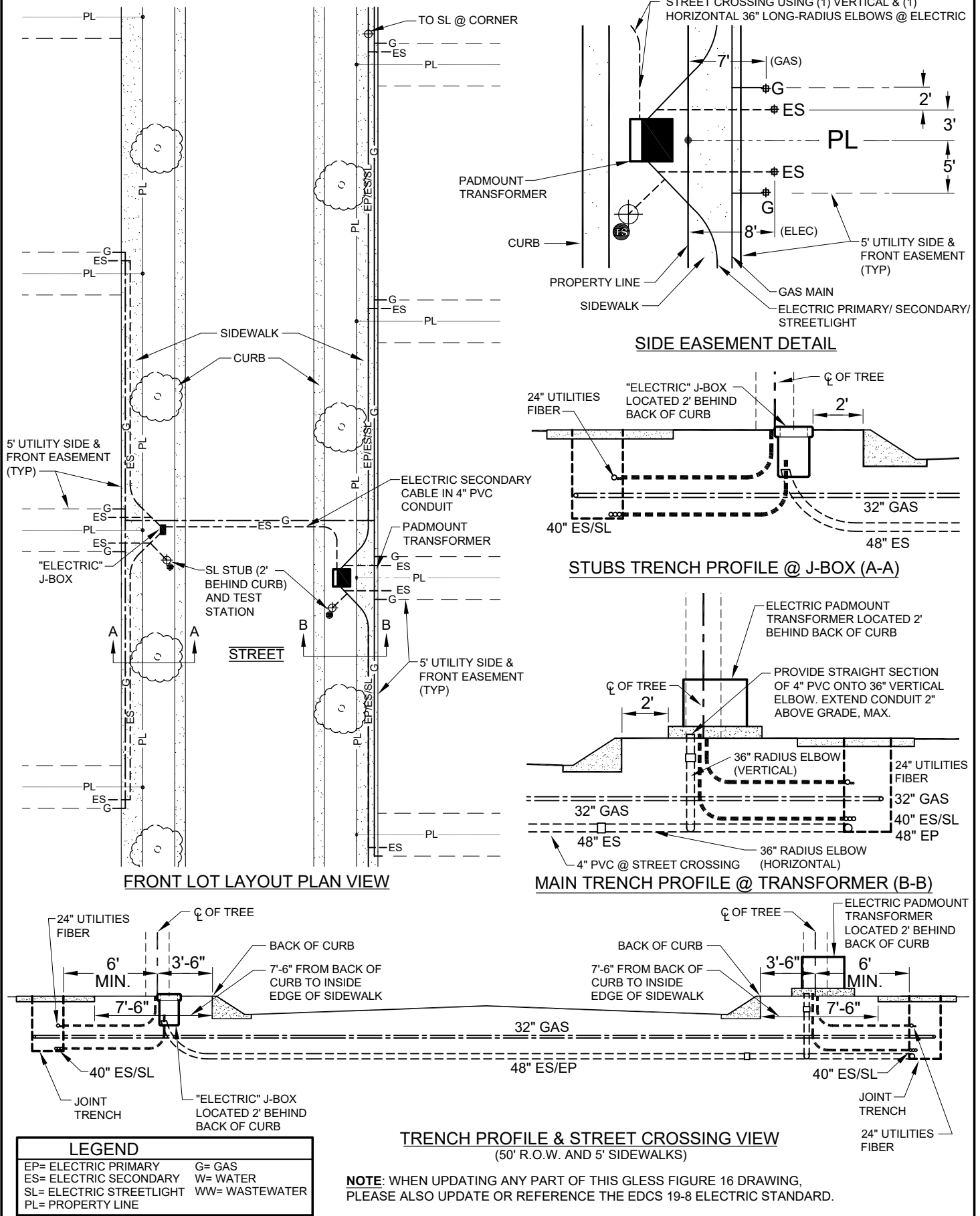

FRONT LOT LAYOUT PLAN VIEW

SIDE EASEMENT DETAIL

STUBS TRENCH PROFILE @ J-BOX (A-A)

MAIN TRENCH PROFILE @ TRANSFORMER (B-B)

TRENCH PROFILE & STREET CROSSING VIEW

(50' R.O.W. AND 5' SIDEWALKS)

LEGEND	
EP= ELECTRIC PRIMARY	G= GAS
ES= ELECTRIC SECONDARY	W= WATER
SL= ELECTRIC STREETLIGHT	WW= WASTEWATER
PL= PROPERTY LINE	

NOTE: WHEN UPDATING ANY PART OF THIS GLESS FIGURE 16 DRAWING, PLEASE ALSO UPDATE OR REFERENCE THE EDCS 19-8 ELECTRIC STANDARD.

FIGURE 16

JOINT TRENCH - FRONT LOT LAYOUT WITH ATTACHED SIDEWALKS AND TREES BEHIND SIDEWALK

(THIS LAYOUT ACCOUNTS FOR 6' SEPARATION FROM ELECTRIC AND GAS LINES TO TREES)

(ATTACHED SIDEWALKS WILL TYPICALLY ONLY BE LOCATED ON CUL-DE-SACS) (50' R.O.W. AND 6' SIDEWALKS)

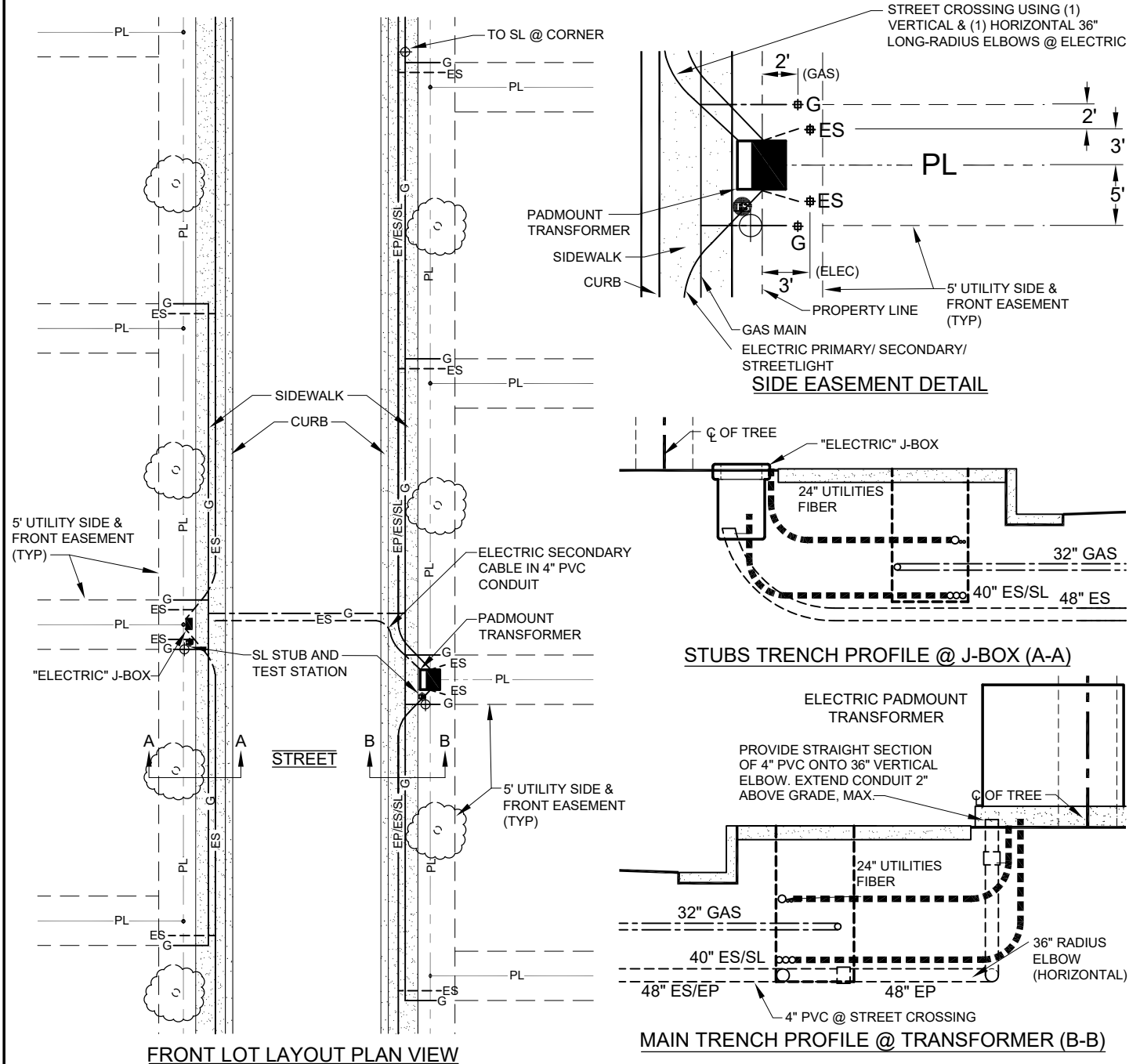

FRONT LOT LAYOUT PLAN VIEW

STUBS TRENCH PROFILE @ J-BOX (A-A)

MAIN TRENCH PROFILE @ TRANSFORMER (B-B)

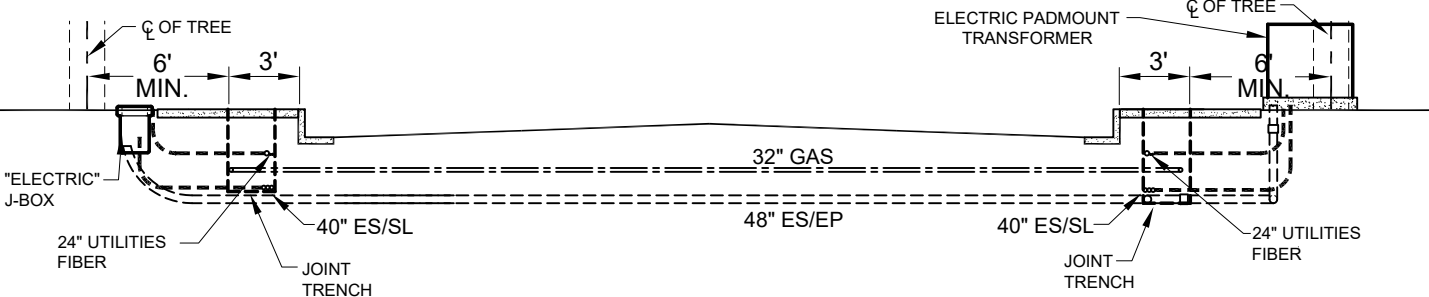

TRENCH PROFILE & STREET CROSSING VIEW
(50' R.O.W. AND 6' SIDEWALKS)

LEGEND	
EP= ELECTRIC PRIMARY	G= GAS
ES= ELECTRIC SECONDARY	W= WATER
SL= ELECTRIC STREETLIGHT	WW= WASTEWATER
PL= PROPERTY LINE	

NOTE: WHEN UPDATING ANY PART OF THIS GLESS FIGURE 16 DRAWING, PLEASE ALSO UPDATE OR REFERENCE THE EDCS 19-8 ELECTRIC STANDARD.

TABLE OF CONTENTS

APPENDIX E

Glossary

Title	Page Number
"Applicant" through "Gas Service Stub".....	E-2
"Grouped Refund Contract" through "Natural Gas Tariffs"	E-3
"Padding" through "Violation"	E-4
"Violation"	E-5

APPENDIX E: GLOSSARY

TERMS AND ABBREVIATIONS

Applicant - A person or entity applying for a gas extension.

Application for Extension of Gas Mains and Services - A standard letter requesting Colorado Springs Utilities to extend its facilities to a specified site.

Agent - The Applicant's representative who is authorized to act for or in the place of the Applicant.

Bell-Hole - An excavation which is deep enough and wide enough to facilitate a gas service line tie-in at the gas service stub end.

Building - A structure (permanent or temporary) containing one or more habitable units covered by a single roof (e.g., shed, house, mobile home, apartment, office, retail establishment, warehouse, etc.).

Contractor - A person who is financially or contractually responsible to undertake the installation of gas service lines for a prospective customer. This person may also be a Certified Service Line Fitter.

Customer - Any person or company applying for, receiving, using or agreeing to take a class of gas service or other services supplied by Colorado Springs Utilities.

Excavation - any operation in which earth is moved or removed by means of any tools, equipment, or explosives and includes augering, backfilling, boring, ditching, drilling, grading, plowing-in, pulling-in, ripping, scraping, trenching, hydro excavating, postholing, and tunneling. Excavation also includes stump grinding and concrete form stakes. For examples of what "Excavation" does not include, see Colorado Revised Statutes § 9-1.5-102

Existing Gas Service Line - A gas service line currently connected to the gas distribution system.

Extension Contract - A contract between the Applicant and Colorado Springs Utilities that describes the terms under which the new facilities (line extension) will be built.

Footprint - The location of a building(s) on a site plan including the location of all operable windows, doors, vents and the proposed meter location.

Fuel Gas Piping - Gas piping which is owned and maintained by the owner of the premises being served; typically the gas piping downstream from the gas meter.

Gas Service Riser - That portion of a gas service line which makes a vertical 90 degree turn rising from the ground to be connected to a gas service riser shutoff valve and gas meter set.

Gas Service Riser Shutoff Valve - A valve located between the gas service riser and gas meter set piping.

Gas Service Riser Vent - A 12 inch by 12 inch opening in a sealed pavement surface from which a gas service riser exits.

Gas Service Stub - Underground gas piping extending from a gas main to the property or utility easement line.

Grouped Refund Contract- A contract used to group several contiguous projects into one refund contract.

Leak Test - Pressurization of a gas service line with air to ensure installation integrity.

Line Extension - A term used to describe the processes of constructing new gas facilities to serve a specific site.

Load Based Refund - Refunds made to Mainline Facilities Refund Contracts; based on the ratio between the connected load and the design load of the new gas facilities.

Load Requirements - The total of all gas appliance input requirements taken from individual manufacturer badges on each appliance. This value may be expressed in British Thermal Units per Hour (BTU/HR) or Cubic Feet per Hour (CFH). (This term may be used synonymously with “total connected load”).

L.U.S.I. - Licensed Utility Service Installer

Main - A distribution line that serves as a common source of supply for more than one service line.

Mainline Facilities Refund Contract - A contract between the Applicant and the Utilities Development Services that replaces the Extension Contract and describes the terms and method for refunding the Applicant for the cost of the Extension.

MAOP – Maximum Allowable Operating Pressure

Master Meter – (where not part of a Master Meter System) A single meter serving multiple premises in the same building, where an underground piping system does not exist downstream of the meter. The owner buys metered gas from the Colorado Springs Utilities, then distributes and sells the gas to the ultimate users.

Master Meter System - A system for distribution of natural gas where the system operator buys metered gas from Colorado Springs Utilities, then distributes and sells that gas to the ultimate users through a privately owned underground piping system.

Meter - An instrument installed and maintained by Colorado Springs Utilities to measure the volume of gas delivered to a customer.

Meter Bank - A group of co-located meters serving a single building with multiple units.

Meter Set - Gas piping, fittings, regulator(s), meter(s) and associated equipment installed between the gas service riser shutoff valve and the connection to the fuel gas piping.

Multi-Meter above Ground Manifold - A manifold specially designed for supplying gas to multi-family structures.

Natural Gas Tariffs - The rules and regulations that Colorado Springs Utilities operates under. These tariffs are established and maintained by the Utilities Board (City Council).

Padding - A back-fill material free of rock, gravel, asphalt and debris. The padding shall be a fine-grained fill material that will pass through a Number 40 sieve and be retained by a Number 200 sieve.

Property Line Valve - A valve installed at or near the property line.

Protective Sleeve - A segment of straight polyethylene plastic pipe used to shield or protect a gas service line from damage where other utility crossings occur or where other underground structures may conflict with separation requirements of a gas service line installation.

Reinstatement - Restoration of a Service Line Fitter's "Certified" status after a period of suspension.

Rejection - Action taken by a Colorado Springs Utilities Construction and Maintenance Department Inspector disapproving an unsatisfactory gas service line installation.

Revenue Based Refund - Refunds made to Single Parcel Refund Contracts; based on the estimated annual revenue generated by new service connections.

Scattered Service Stub - A service stub installed from an existing main to serve one building.

Service Line - A distribution line that transports gas from a common source of supply to an individual customer, to two adjacent or adjoining residential or small commercial customers, or to multiple residential or small commercial customers served through a meter header or manifold. A service line ends at the outlet of the customer meter or at the connection to a customer's piping, whichever is further downstream, or at the connection to customer piping if there is no meter.

Single Parcel Refund Contract - A contract between the Applicant and the Utilities Development Services that replaces the Extension Contract and describes the terms and method for refunding the Applicant for the cost of the Extension.

Standard Easement Document - A standard document to be used when installing utilities in private streets or right-of-ways.

Structure - Underground and surface structures include, but are not limited to foundation and basement walls, patios or other sealed surfaces, which abut a building, or it's foundation. Excluded from this category are public sidewalks and unavoidable structures where a protective sleeve is required.

Utilities Design CAD File (UDCF) - UDCF is a computerized system, which allows Developers, Engineers and Architects, remotely from their offices, to electronically submit development plans and requests, as well as the ability to download utilities land base information

Utilities Addressing Plan (UAP) - A plan that gives general information about a project including the geometry of the site.

Vent - An intake or exhaust port (e.g., fresh air intake ducts, dryer exhausts, range hood exhausts, fireplace makeup air ducts, etc.).

Violation - Unsatisfactory installation resulting from improper work practices, material, methods or procedures, including but not limited to:

- A kink or unacceptable gouge(s) in the pipe,
- An improper plastic fusion,
- Use of unapproved materials,

- Covering or turning face down the identification print line of plastic pipe or the identification label of a plastic fitting,
- Deception, (i.e., alteration of a gas service stub, pressurization of a gas service line with air prior to inspection to disguise leakage, changing identification labels on fittings, unauthorized use of a Certified Service Line Fitter Certification Card, etc.),
- Failure to properly size service lines,
- Removal of Colorado Springs Utilities electronic markers, both flat and spherical,
- Failure to have back-fill material a minimum of 2 feet from the edge of the bell-hole,
- Failure to display a visible foundation mark and/or address,
- Failure to display a temporary street name whenever permanent street signs are not present.

This Page Left Intentionally Blank

TABLE OF CONTENTS

APPENDIX F

Colorado Springs Utilities Plastic Joining Procedure (Socket only)

Title	Page Number
Colorado Springs Utilities Plastic Joining Policy and Procedure (Socket only).....	F-2

APPENDIX F
PLASTIC JOINING POLICY AND PROCEDURE
(SOCKET FUSION ONLY)

POLICY

The fusion procedures that follow are provided to address the joining of polyethylene (PE) plastic material that is fused in the Colorado Springs Utilities natural gas distribution system. The purpose of this procedure is to establish a defined method that results in quality polyethylene fusions and complies with 49 CFR Part 192, Subpart F – Joining of Materials Other than by Welding. Compliance with these procedures is required by all Colorado Springs Utilities and contractor personnel that work on the Colorado Springs Utilities natural gas system.

The material preference for much of the Colorado Springs Utilities' natural gas distribution system is plastic. PE pipe within the Colorado Springs Utilities distribution system cannot operate at the higher pressures of steel pipe, but where appropriate should be used as it is much easier to install and does not require cathodic protection.

Plastic material currently approved by Colorado Springs Utilities includes PE 2708 (Medium Density Polyethylene (MDPE)) with some fittings being PE 4710 (High Density Polyethylene (HDPE)). There are remaining vintage materials in the gas system, such as Aldyl A that was used starting in 1965. Fusions of vintage and dissimilar plastic materials (non-HDPE or MDPE) requires the use of electrofusion. For additional general information on gas system vintage materials see <https://plasticpipe.org/pdf/ppdc-mfg-database.pdf>.

Plastic pipe joints must be designed and installed in accordance with Title 49 CFR Part 192.281. Much of the heat fusion (saddle, butt, and socket) procedures in this document follow the fusion procedures developed by Duraline. Permission from Duraline was obtained to use their procedures within Colorado Springs Utilities' procedures. A few small procedure modifications were incorporated due to some minor differences in fusion practices at Colorado Springs Utilities. In addition, the procedures incorporate recommendations from the Plastics Pipe Institute (PPI) Technical Reports (TR) TR-41 and TR-33 and ASTM F2620-12: Standard Practice for Heat Fusion Joining of Polyethylene Pipe and Fittings.

Title 49 CFR Part 192.281 requires that electrofusion joints must be made using the equipment and techniques prescribed by the fitting manufacturer, or using equipment and techniques shown, by testing joints to the requirements of §192.283(a)(1)(iii), to be equivalent to or better than the requirements of the fitting manufacturer. Much of the electrofusion procedure follows the electrofusion procedures developed by MT Deason and Georg Fischer Central Plastics (GFCP) (approved manufacturers). Both manufacturers' procedures were qualified to the requirements of 49 CFR Part 192.283. Permission from both manufacturers was obtained to use their sections of their procedures within Colorado Springs Utilities' procedures. Colorado Springs Utilities procedures reflect aspects of both manufacturers' procedures.

Pursuant to 49 CFR 192.283(a), an operator is required to qualify plastic fusion joining procedures before the procedure is used in the field. The procedures have been lab tested by the manufacturers and internally by a third party and shown to consistently produce sound fusion joints and in compliance with 49 CFR Part 192.283 when the procedure is followed correctly.

Joining of plastic pipe using these procedures can only be performed by qualified persons¹. Qualified joiners are qualified to inspect joints, including their own joints.

Per 49 CFR Part 192.756, all fusion equipment shall be maintained per manufacturer's recommended practices and specifications.

Prior to joining plastic by heat fusion, ensure that the plastic material has not expired. MDPE can be exposed to ultraviolet light (UV) for no more than 3 years. HDPE can be exposed for no more than 10 years². Expired materials shall not be used and shall be disposed of.

Fittings should always be stored indoors, in their original packaging, until the time of installation. Fittings with an unknown storage history or that have been exposed to questionable storage conditions should not be used.

SOCKET FUSION

Socket Fusion Description

This technique involves simultaneously heating the outside surface of a pipe end and the inside surface of a fitting socket, which is sized to be smaller than the smallest outside diameter of the pipe. After the proper melt has been generated at each face to be mated, the two components are joined by inserting the pipe into the fitting. The fusion is formed at the interface resulting from the interference fit. The melts from the two components flow together and fuse as the joint cools.



Equipment

Per 49 CFR Part 192.756, all fusion equipment shall be maintained per manufacturer's recommended practices and specifications.

It is the responsibility of the onsite qualified fusion operators to inspect tools and equipment before fusing on the gas system. Damaged or worn equipment or tools should not be used until repaired.

Ensure you have the following equipment for this fusion:

- *chamfer tool*—a device that is used to chamfer the outside edge of the pipe. The chamfer allows the pipe end to easily enter the pipe heater face and easily enter the heated fitting.
- *depth gage*—a device that is used to locate the rounding clamp a prescribed distance from the end of the pipe. Often part of the chamfer tool.
- *heating tool*—a device used to heat the heater faces.
- *fitting heater face or adapter*—A block of heat conducting material that attaches to the heating tool and is dimensioned to melt the internal surface of the fitting socket.
- *pipe heater face or adapter*— A block of heat conducting material that attaches to the heating tool and is dimensioned to melt the external surface of the pipe.
- *rounding clamp or cold ring*—a device that is clamped around the pipe to round the pipe and limit the distance the pipe end goes into the pipe heater face and the socket fitting.
- *Isopropyl alcohol wipes* (96% or higher concentration isopropyl alcohol) to clean pipe and fitting.
- *Clean, dry, lint free cloth or paper towel.*



Safety

Use Colorado Springs Utilities approved appropriate personal protective equipment (PPE) when fusing plastic pipe (FR clothing, gloves, hard hat, and eye protection) at all times.

Although the fusion irons are not hot enough to ignite natural gas, they are hot enough to seriously burn/injure an employee. Follow all safety precautions in the fusion equipment manuals.

Keep a fire extinguisher on the fusion site and when in a gaseous atmosphere must be manned.

Static electricity can build up inside and outside of plastic pipe and a static spark is hot enough to cause personal injury and ignite natural gas. Properly ground plastic pipe squeezers before cutting or fusing.

Electrical shock can occur as electrical generators are used to supply the electricity necessary to heat the fusing irons. Always use a three-prong grounding plug with the heating irons and avoid fusing while standing in water. If there are no other options to fuse while standing in water, always take extra precaution, use appropriate PPE, and ensure that the cord does not make contact with the water.

Check the power cord of the fusion iron for any frays or cracks. If it shows any damage, repair or replace it.

It's very important NOT to contaminate the fusion surfaces with dirt, grit, body oils, perspiration, or other contaminants.

Procedure

Preparation

Cut the pipe end squarely.

Clean the inside and outside of the pipe or fitting (components) ends and areas to be fused by wiping with a new alcohol wipe (preferred) or with a clean, dry, lint free cloth or paper towel. Remove all foreign matter. Never use a petroleum-based cleaner or soap solution as they can prevent a perfect bond.

After the fusion areas of the pipe have been cleaned, do not touch them with bare skin as the oils in your skin can also prevent a perfect bond from developing.

Periodically check the faces of the heating iron prior to fusing to make sure they are clean and smooth so they won't collect dirt and will transfer heat into the pipe ends equally.

If the faces are scratched or gouged, they should be replaced.

If they need to be cleaned, use 100% cotton cloths. Synthetic materials leave a residue that may hinder the fusion.

Verify heating temperature of the heating iron is within the specified temperature range (490oF – 510oF).

In order to obtain a proper melt, a uniform temperature must be maintained across the heating surface.

All points on both heating surfaces where the heating surfaces will contact the pipe and fitting must be within the prescribed minimum and maximum temperatures.

Chamfer the outside edge of the pipe end slightly. The pipe should be free of debris and burrs.

Place the cold ring on the pipe as determined by the depth gauge/chamfer tool. Place the depth gauge over the chamfered end of the pipe.

Clamp the cold ring immediately behind the depth gauge.



Heating

Review the recommended heating times in Table 4.1. Insert the fitting onto the male heating face. The fitting should be held against the back surface of the male heater face. Insert the pipe into the female heating face. The female socket heating face should be against the cold ring clamp. The heating time begins after this has been completed. Hold the pipe and fitting in place against the heater faces for the recommended heating time as shown in Table 4.1.

HEATING AND COOLING TIMES

Pipe Size	PE2708 fused to MDPE fittings	
	Heating Time seconds	Cooling Time seconds
1/2" CTS	6 – 7	30
3/4" IPS	8 – 10	30
1" IPS	10 – 12	30
1-1/4" IPS	12 – 14	45
2" IPS	16 – 19	45

Fusing and Cooling

At the end of the heating time, simultaneously remove the pipe and fitting straight out from the tool using a “snap” action. Do not torque or twist the pipe or fitting during removal.

A quick inspection should be made of the melt pattern on the pipe end and fitting socket. If there is evidence of an incomplete melt pattern, do not continue with the fusion procedure.

Immediately insert the pipe straight into the socket of the fitting so that the cold ring is flush against the end of the fitting socket.

While cooling, pressure should be maintained on the fusion per the recommended cooling time shown in Table 4.1 before removing the cold ring.

Allow the joint to cool 5 minutes before removing the cold ring. An additional 10 minutes of cooling time is recommended before exposing the joint to any type of stresses (i.e., burial or testing).

Inspection

Qualified joiners are qualified to inspect joints, including their own joints.

Visually inspect the fusion joint. A complete impression of the rounding clamp should be visible in the melt pattern at the end of the socket. There should be no gaps, voids or unbonded areas. Review Table 4.2 for possible issues.

Cold Weather Considerations (fusing below 55°F)

The pipe and fitting surfaces to be joined or held in clamps shall be dry and clean and free of ice, frost, snow, dirt, and other contamination. If ice or frost is present in the fusion area, remove it by lightly tapping or scraping the area. Shield the heating iron and fusion area from any wind, snow and freezing rain.

Make sure the heater iron faces maintain a temperature of 500°F ($\pm 10^\circ\text{F}$).

Conduct a test melt on cold scrap pipe. If the initial melt pattern is incomplete, try a 3 second longer cycle on another cold piece of scrap pipe. Continue until a uniform melt pattern is obtained on the fitting and the pipe.

Do not increase the pressure to compensate for the cold.

Fusion is generally not recommended below -4°F (-20°C) without special provisions such as a portable shelter or trailer or other suitable protective measures with auxiliary heating.

ACCEPTABLE FUSIONS

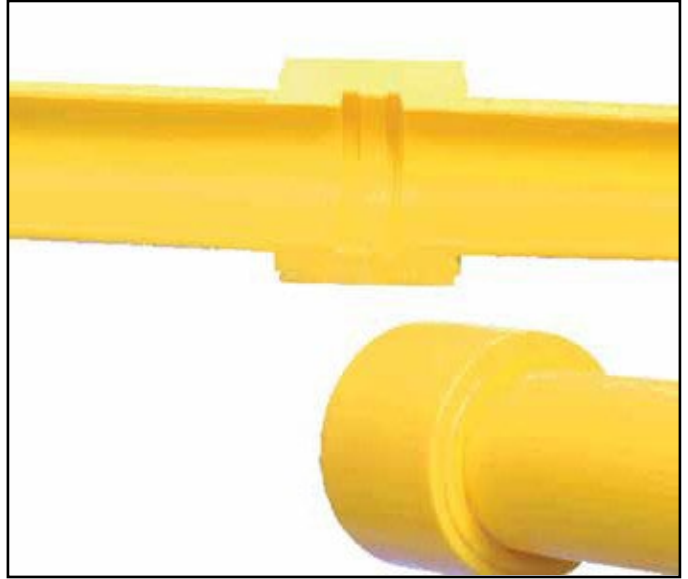

Proper Alignment and Stab Depth

Melt Bead Flattened Due to Cold Ring - No gaps or voids

Area where likely
gaps and voids
might occur

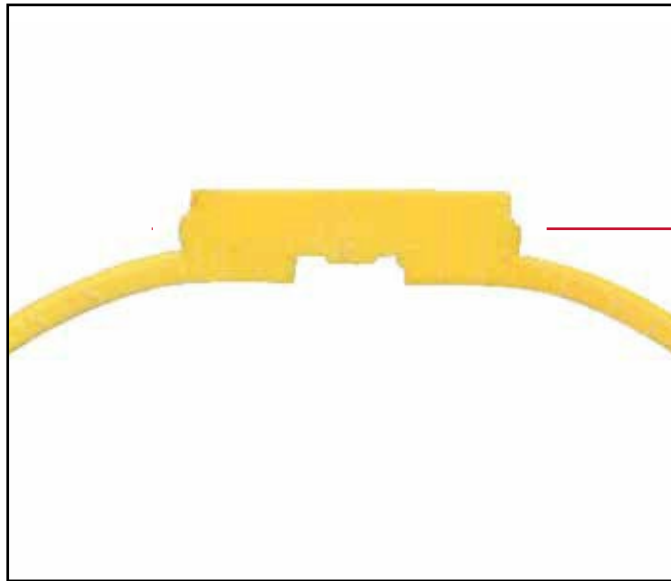

Area where likely
gaps and voids
might occur

Bend Back Testing - No Gaps or Voids

UNACCEPTABLE FUSIONS



Short Stab Depth Caused by Failure to Use a Depth Gauge

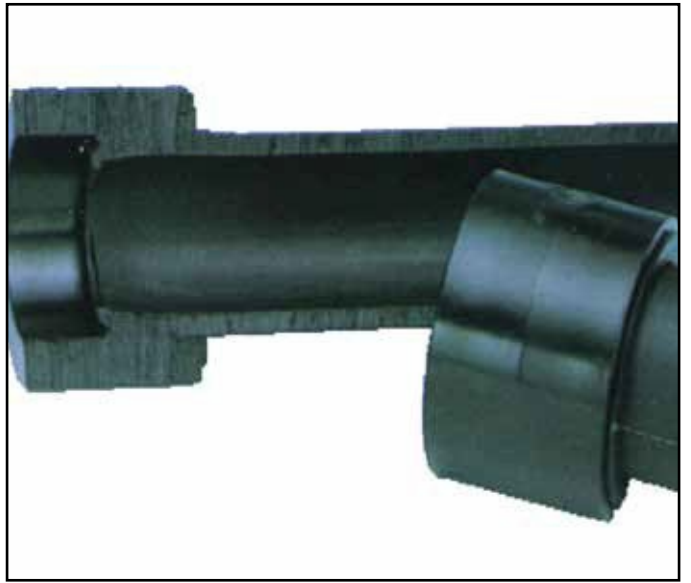

Excessive Stab Depth Caused by Failure to Use a Cold Ring



Misalignment

SOCKET FUSION TROUBLESHOOTING GUIDE

Observed Condition	Possible Cause
<ul style="list-style-type: none"> • No evidence of cold-ring impression in socket fitting melt bead 	<ul style="list-style-type: none"> • Insufficient heating time • Depth gauge not used • Cold ring not used • Cold ring set at incorrect depth
<ul style="list-style-type: none"> • Gaps or voids around the pipe at the socket fitting edge 	<ul style="list-style-type: none"> • Pipe or fitting not removed straight from heater face • Components not joined together straight when fusing • Cold ring not used • Cold ring set at incorrect depth
<ul style="list-style-type: none"> • Wrinkled or collapsed pipe end 	<ul style="list-style-type: none"> • Cold ring not utilized • Cold ring set at incorrect depth • Incorrect heating sequence
<ul style="list-style-type: none"> • Voids in fusion bond area 	<ul style="list-style-type: none"> • Pipe or fitting not removed straight from heater face • Components not joined together straight when fusing • Cold ring not used • Cold ring set at incorrect depth
<ul style="list-style-type: none"> • Unbonded area on pipe at end of pipe 	<ul style="list-style-type: none"> • Cold ring not used • Cold ring set too deep
<ul style="list-style-type: none"> • Socket melt extends past end of pipe 	<ul style="list-style-type: none"> • Cold ring set too shallow
<ul style="list-style-type: none"> • Rough, sandpaper-like, bubbly, or pockmarked melt bead surface 	<ul style="list-style-type: none"> • Hydrocarbon (gasoline vapors, spray paint fumes, etc.) contamination

Resources

Duraline, 2018. Heat Fusion Joining Procedures.

This Page Left Intentionally Blank

COLORADO SPRINGS UTILITIES GAS LINE EXTENSION/SERVICE INSTALLATION

Phone Numbers and Contact Information

PLANNING

Gas Plan Review

Field Engineering North.....668-4985
 Field Engineering South.....668-5564

Utilities Development Services.....668-8259

Customer Contract Administration.....668-8111

Underground Utility Line Locations

Colorado 811/UNCC/Before you dig (All Colorado Utilities) - Call 3 business days before digging.....811
 Central Locating Dispatch (For Design of Colorado Springs Utilities gas, electric, water and wastewater)
 Main Number.....668-7205

DESIGN

FIMS

Service Lines/ Plat Cards- Records Management.....668-4405
 Land Base Maps, Plat Maps.....668-8779
 Utilities Addressing Plan (UAP) and Utilities Design CAD Files (UDCF).....668-8779

Design of Gas Main Line Extensions

Field Engineering North.....668-4985
 Field Engineering South.....668-5564

North Workcenter Field Engineering

7710 Durant Drive, Colorado Springs, CO 80947-2150/ Fax: 719-668-4998

Name	Title	Area	Office	Cell
Tim Benedict	Field Engineering Supervisor	Gas & Joint Trench	719-668-3574	719-661-5505
Justin Noel	Field Engineer	Gas	719-668-4872	719-377-0419
Ryan Pogue	Field Engineer	Gas	719-668-7840	719-828-4618
Tony Sarcomo Jr	Field Engineer	Gas	719-668-1857	719-374-2527
Tim Williams Jr	Field Engineer	Gas	719-668-7276	719-257-8426
Dylan Quintana	Field Engineer	Joint Trench	719-668-8330	719-675-0099
Casey Sullivan	Field Engineer	Joint Trench	719-668-5745	719-440-9975
Steve Travnicek	Field Engineer	Joint Trench	719-668-7716	719-258-7209
Tim Wendt	Field Engineer	Joint Trench	719-668-4962	719-237-7968

South Workcenter Field Engineering
1521 Hancock Expressway, Colorado Springs, CO 80947-1812/ Fax: 719-668-5956

Name	Title	Area	Office	Cell
Mary Hoaglund	Field Engineering Supervisor	Electric	719-668-4083	719-650-9151
Jim Bradbury	Field Engineer	Electric	719-668-3243	
Dave Coker	Field Engineer	Electric	719-668-8796	719-649-2665
Rudy Duran	Field Engineer	Electric	719-668-8762	719-464-7961
Josh Hoepfner	Field Engineer	Electric	719-668-3242	719-322-6048
Kyle Leibhart	Field Engineer	Electric	719-668-8767	719-313-1504
John Martinez	Field Engineer	Electric	719-668-3244	719-323-4778
Joe Reuter	Field Engineer	Electric	719-668-7885	719-499-5798
Eric Thetford	Field Engineer	Electric	719-668-4510	719-322-5472

Gas Main Pressure.....	668-3524
Gas Service Stub Location.....	668-3524
Elevated Delivery Pressure & Propane Conversion Requests	
Field Engineering North.....	668-4985
Field Engineering South.....	668-5564

C O N S T R U C T I O N

Colorado Springs Utilities Construction Scheduling.....	668-3525
Quality Control & Inspections.....	668-3667

S E R V I C E I N S T A L L A T I O N
--

Building Permits (Regional Building Department).....	327-2880
Houseline Inspections (Regional Building Department).....	327-2883
Gas Meter Inspections/Scheduling.....	668-7350
Colorado Springs Utilities Machine Weld Shop.....	668-5384
Gas Construction Operations and Maintenance Department Manager.....	668-3664
Ops/Field Support.....	668-8352
Appointment Scheduling Gas/Electric Service Inspection & Tie-Ins.....	668-2TIE
Gas Standby.....	668-3520
Gas Field Service Inspections/Meter Sets.....	668-7350
Advanced Metering Technologies Group (AMT).....	668-5525
Supervisor.....	668-3505

OTHER TELEPHONE NUMBERS

Colorado Springs Utilities Customer Service	448-4800
Gas Utility Emergencies	448-4800
Damage Claims	385-5960
General Accounting (Inquiry for Time-and-Material Refunds).....	668-8550
City of Colorado Springs Revocable Permit Coordinator	385-5905
Utility Safety Outreach and Education	668-8386
Call for free utility safety outreach and education (or email communityoutreach@csu.org)	
Warehouse	
North Work Center	668-4981
South Work Center	668-5550

NORTH WORK CENTER
 7710 DURANT DRIVE, P.O. BOX 1103
 MAIL CODE 2150
 COLORADO SPRINGS, CO
 80947-2150
 MAIN PHONE: 668-4985
 FIELD ENGINEERING FAX: 668-4998

GAS FIELD ENGINEERS AREAS



TIM BENEDICT
GAS AND JOINT TRENCH FIELD
ENGINEERING SUPERVISOR
 668-3574
 661-5505

GAS
TIM WENDT
668-4962
237-7968

GAS
TONY SARCOMO
668-1857
374-2527

LINDA ISAACSON
PLANNER ANALYST
SR. 668-4691

JULIE GROSE
ADMIN SPEC.
668-8129

ELECTRIC/WATER/GAS
EMERGENCY (ONLY):
DISPATCH 668-8800
CUSTOMER SERVICE 448-4800
ADDRESS: 111 S. CASCADE,
COLORADO SPRINGS, CO 80903
HOURS: M-F 7am-7pm / SAT
8am-12pm
CALL BEFORE U-DIG: 811

GAS
RYAN POGUE
668-7840
828-4618

GAS
JUSTIN NOEL
668-4872
377-0419

JULIE GROSE
ADMIN SPEC.
668-8129

ERIC GUNDRED
PLANNER ANALYST
SR. 668-5558

MARY HOGLUND
ELECTRIC FIELD
ENGINEERING SUPERVISOR
 668-4083
 650-9151

GAS
TIM WILLIAMS
668-7276
257-8426

GAS
TIM WENDT
668-4962
237-7968

SOUTH WORK CENTER
 1521 HANCOCK EXPRESSWAY,
 P.O. BOX 1103, MAIL CODE 1812
 COLORADO SPRINGS, CO
 80947-1812
 MAIN PHONE: 668-5564
 FAX: 668-5956

Missing or invalid reference
 File: ..\Xref PdfField Engineering Base Coverage Map.pdf

NORTH WORK CENTER
 7710 DURANT DRIVE, P.O. BOX 1103
 MAIL CODE 2150
 COLORADO SPRINGS, CO
 80947-2150
 MAIN PHONE: 668-4985
 FIELD ENGINEERING FAX: 668-4998

TIM BENEDICT
GAS AND JOINT TRENCH FIELD
ENGINEERING SUPERVISOR
 668-3574
 661-5505

LINDA ISAACSON
PLANNER ANALYST SR.
 668-4691

JULIE GROSE
ADMIN SPEC.
 668-8129

ELECTRIC/WATER/GAS
EMERGENCY (ONLY):
DISPATCH 668-8800
CUSTOMER SERVICE 448-4800
ADDRESS: 111 S. CASCADE,
COLORADO SPRINGS, CO 80903
HOURS: M-F 7am-7pm / SAT
8am-12pm
CALL BEFORE U-DIG: 811

JULIE GROSE
ADMIN SPEC.
 668-8129

ERIC GUNDRUD
PLANNER ANALYST
SR. 668-5558

MARY HOGLUND
ELECTRIC FIELD
ENGINEERING SUPERVISOR
 668-4083
 650-9151

SOUTH WORK CENTER
 1521 HANCOCK EXPRESSWAY,
 P.O. BOX 1103, MAIL CODE 1812
 COLORADO SPRINGS, CO
 80947-1812
 MAIN PHONE: 668-5564
 FAX: 668-5956

JOINT TRENCH AREA MAP



JOINT TRENCH
TIM WENDT
 668-4962
 237-7968

JOINT TRENCH
DYLAN QUINTANA
 668-8330
 675-0099

JOINT TRENCH
CASEY SULLIVAN
 668-5745
 440-9975

JOINT TRENCH
STEVE TRAVNICEK
 668-7716
 258-7209

JOINT TRENCH
TIM WENDT
 668-4962
 237-7968

Missing or invalid reference
 File: ..\Xref PdfField Engineering Base Coverage Map.pdf

NOTES

NOTES



Colorado Springs Utilities

It's how we're all connected